

REMER
RUBINETTERIE



NEWS 2023



FINISHES NEWS

VISUAL INOX - RAME SPAZZOLATO
VISUAL STEEL - BRUSHED COPPER

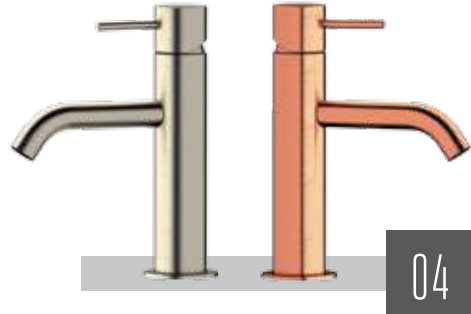

04



FAUCETS NEWS

ELEMENT



08

SLASH & DOT



20

MISCELATORI A INCASSO
BUILT-IN MIXERS



36

SOFFIONI - SHOWER HEAD



52

SHUT-OFF



56

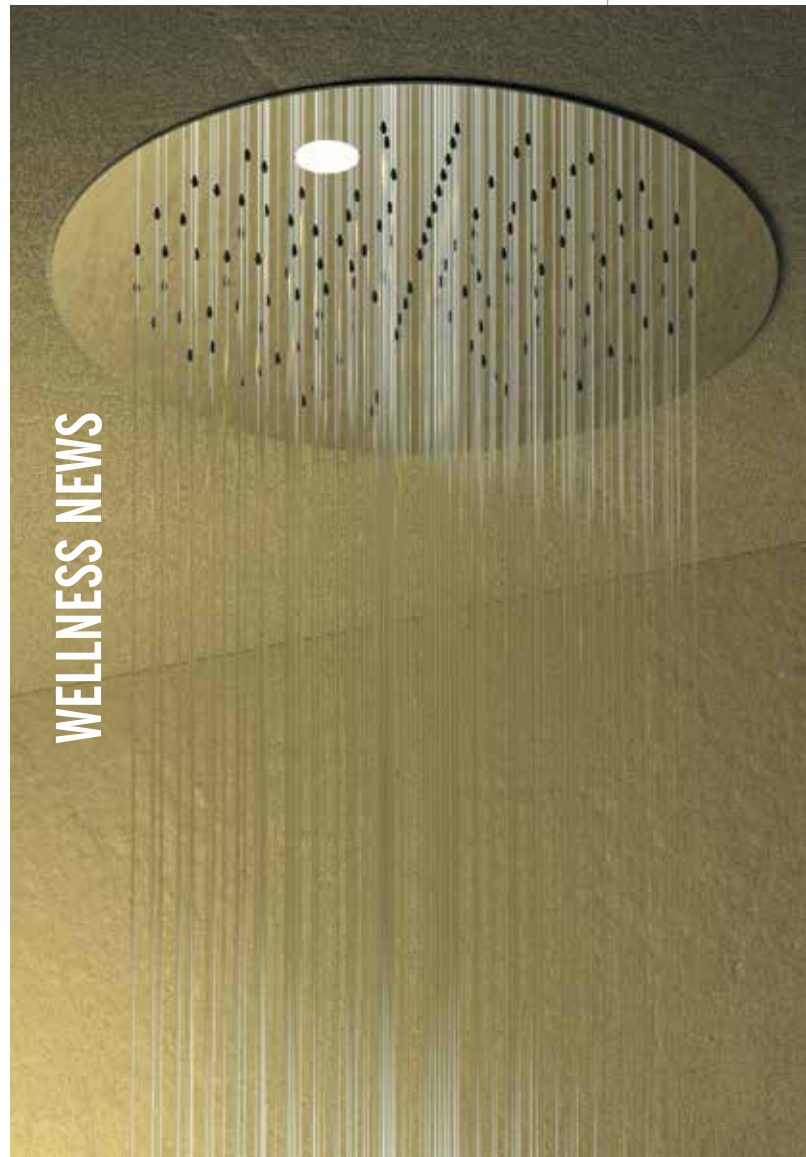

WELLNESS NEWS

ACQUA DEPURATA
PURIFIED WATER



60



KITCHEN NEWS

NEWS FINITURE FINISHES NEWS

FIN 1



NO

Nero opaco
Matt black



BO

Bianco opaco
Matt white



NP

Nichel spazzolato
Brushed nickel



NEW

XV

Visual inox
Visual steel

FIN 2



CFP

Cromo nero spazzolato
Brushed black chrome

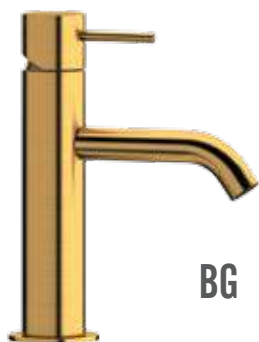

BG

Oro spazzolato
Brushed gold

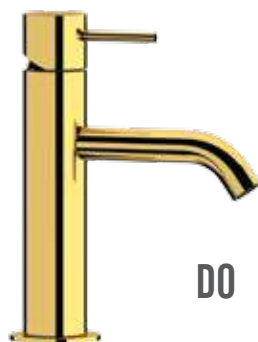

DO

Oro lucido
Shiny gold

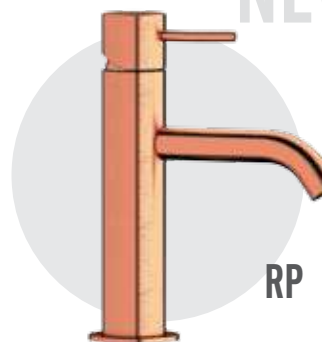

NEW

RP

Rame spazzolato
Brushed copper

TABELLA FINITURE FINISHING TABLE

Crea uniche combinazioni di arredo personalizzando la rubinetteria di bagno e cucina con le opzioni di finitura. Un ventaglio di 8 colori, oltre al cromato, che si inseriscono con facilità in ambienti sia classici che moderni per rispondere alle esigenze stilistiche dei ogni progetto creativo.

Verifica qui i colori di finitura disponibili per ogni collezione di rubinetteria:

Create unique furniture combinations for bathroom and kitchen by customizing the faucets with the finishing options. A range of 8 colours, in addition to chrome, that easily fit into both classic and modern interiors to meet the stylistic needs of all Your creative designs.

Check here the finishing colours available for each faucet collection:

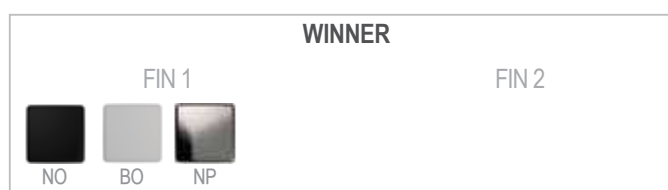
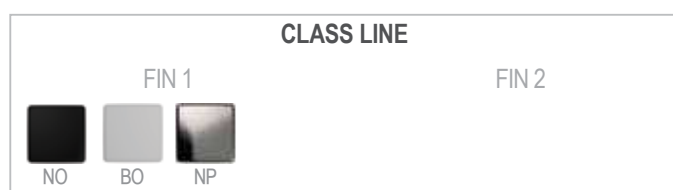
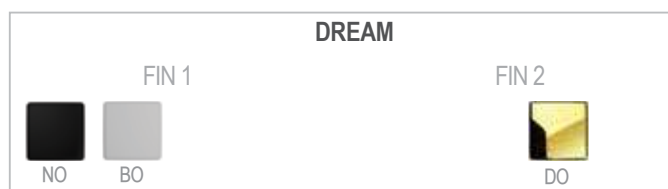
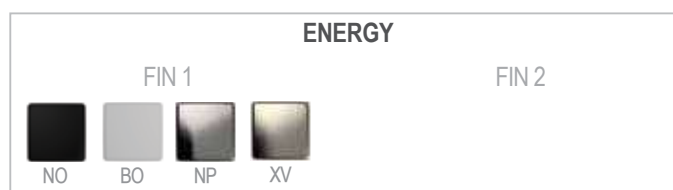
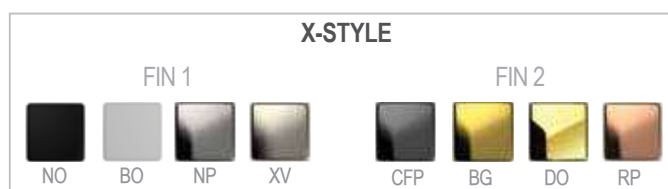
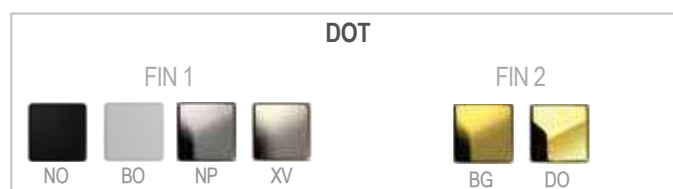
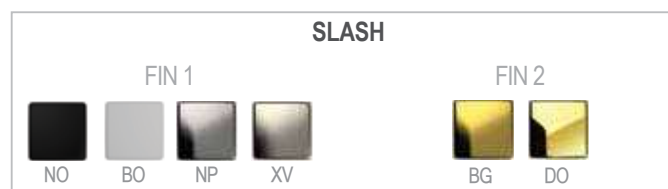

2023

**NEWS RUBINETTERIA
FAUCETS NEWS**



ELEMENT

PAG 8



SLASH DOT &

PAG 20

ELEMENT



La collezione di rubinetteria ELEMENT esprime un'eleganza moderna data dall'essenzialità delle forme e dalla particolarità dell'impugnatura di miscelazione.

L'assenza di tagli posteriori sulla leva e la basetta spessa con doppia inclinazione contribuiscono all'equilibrio estetico dell'intera figura. Cartuccia a dischi ceramici Ø 35 mm. Collezione disponibile in 8 colori di finitura, oltre al cromato.

Collezione disponibile da: Luglio 2023



The ELEMENT faucet collection expresses a modern elegance given by the essentiality of the shapes and by the peculiarity of the mixing handle.

The absence of back cuts on the lever and the thick base with double inclination contribute to the aesthetic balance of the whole figure. Ceramic disc cartridge Ø 35 mm. Collection available in 8 finishing colors, in addition to chrome.

Collezione disponibile da: Luglio 2023





▲
B0 bianco opaco
matt white

▲
D0 oro lucido
shiny gold

ELEMENT

OPZIONI DI FINITURA

Questa collezione di rubinetteria è disponibile in diversi colori di finitura, scegli il colore perfetto per il tuo progetto di arredo!

Per confermare la propria scelta, aggiungere il codice della finitura al termine del codice prodotto al momento dell'ordine.

ELEMENT

FINISHING OPTIONS

This faucet collection is available in different finishing colours, choose the perfect one for your interior!

To confirm your choice, add the finish code at the end of the product code when placing your order



XV visual inox
visual steel



RP rame spazzolato
brushed copper

CR



cromo
chrome

CR

FIN 1



nero opaco
matt black

NO



bianco opaco
matt white

BO



nichel spazzolato
brushed nickel

NP



visual inox
visual steel

XV

FIN 2



cromo nero spazzolato
brushed black chrome

CFP



oro spazzolato
brushed gold

BG



oro lucido
shiny gold

DO



rame spazzolato
brushed copper

RP

MISCELATORI LAVABO - WASHBASIN MIXERS



ET10

Miscelatore monocomando per lavabo, con scarico.
Single-lever basin mixer, with pop-up waste.



ET10LXL

Miscelatore monocomando alto per lavabo, scarico click-clack con troppopieno incluso.
High single-lever basin mixer, click-clack waste with overflow included.



ET11LXL

Miscelatore monocomando alto per lavabo, senza scarico.
High single-lever basin mixer, without waste.



ET12

Miscelatore monocomando per lavabo, senza scarico e senza foro posteriore sul corpo.
Single-lever basin mixer, without waste and without rear body hole.

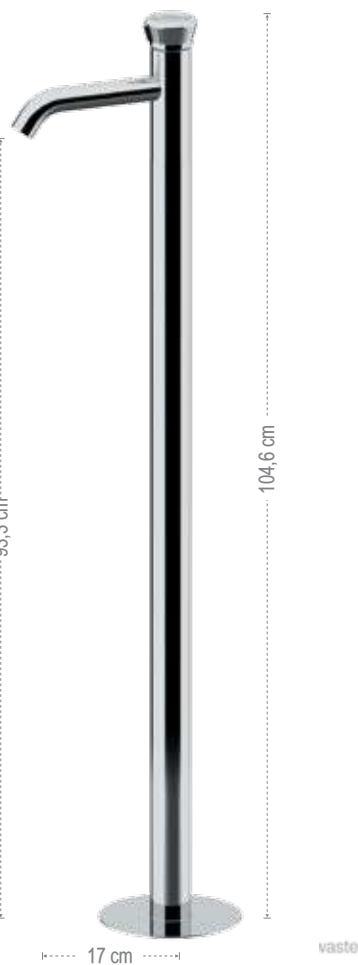

ET18

Miscelatore monocomando da pavimento per lavabo, scarico click-clack con troppopieno incluso.
Floor mounting single-lever basin mixer, click-clack waste with overflow included.



ET57

Miscelatore monocomando per lavabo a due fori. Scarico non incluso.
2-hole single-lever basin mixer. Waste not included.



ET57L

Miscelatore monocomando per lavabo a due fori, con bocca L. Scarico non incluso.
2-hole single-lever basin mixer, with L spout. Waste not included.



MISCELATORI PER LAVABO A INCASSO - BUILT-IN WASHBASIN MIXER



ET15

Miscelatore monocomando a incasso per lavabo. Piastra ultra-piatta. Lunghezza bocca 18 cm

Single-lever built-in basin mixer. Ultra-flat flange. Spout length 18 cm.

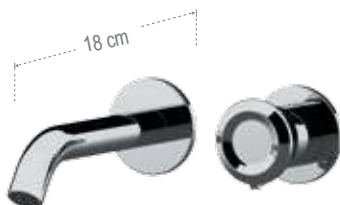

ET15P

Miscelatore monocomando a incasso per lavabo, su due piastre tonde separate. Lunghezza bocca 18 cm.

Built-in single-lever basin mixer with two separate round plates. Spout length 18 cm.

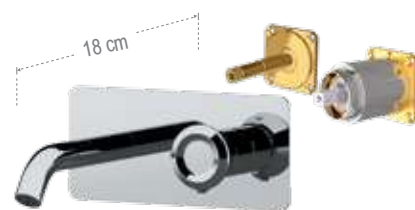

ET15KB

Miscelatore monocomando a incasso per lavabo da abbinare al box incasso. Piastra ultra-piatta. Lunghezza bocca 18 cm.

Single-lever built-in basin mixer, with ultra-flat wall flange. To match with the built-in box. Spout length 18 cm.

+



RRBOX15

Box da incasso per miscelatore monocomando a incasso per lavabo.

Built-in box for single-lever built-in basin mixer.

MISCELATORI PER BIDET - BIDET MIXERS



ET20

Miscelatore monocomando per bidet, con scarico.

Single-lever bidet mixer, with pop-up waste.



ET22

Miscelatore monocomando per bidet, senza scarico e senza foro posteriore sul corpo.

Single-lever bidet mixer, without waste and without rear body hole.



ET65

Set shut-off comprensivo di: miscelatore a incasso con supporto doccia/presa acqua, doccetta a pulsante, tutto in ottone. Flessibile doccia cm 120.

"Shut-off set including: built-in mixer with shower holder/water punch on flange, shut-off hand shower, all in brass. Flexible hose cm 120".

MISCELATORI PER VASCA E DOCCIA - SHOWER AND BATH MIXERS

**ET02**

Miscelatore monocomando per vasca, con kit doccia in ottone ad 1 funzione. Flessibile 150cm.

Wall mounted single-lever bath mixer with 1-function brass hand shower kit. 150cm flexible hose.

**ET05**

Miscelatore monocomando per vasca, senza kit doccia.

Wall mounted single-lever bath mixer, without shower kit.

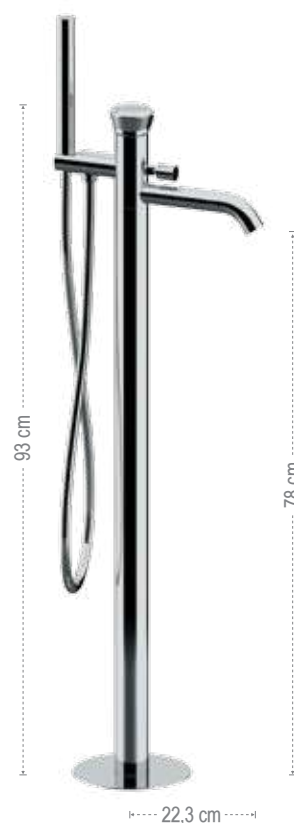
**ET08**

Miscelatore bordo vasca da pavimento, con deviatore e kit doccia in ottone.

Floor mounting single-lever bath mixer, with diverter and brass hand shower kit.

2 VIE - 2-WAY



ET53D2

Set a incasso a 2 vie per vasca, include: miscelatore monocomando, deviatore a 2 uscite e bocca a muro su piastra unica rettangolare ultra-piatta; set doccia su piastra quadrata ultra-piatta con presa acqua, supporto integrato, doccetta in ottone e flessibile 150cm.
2-way built-in set for bathtub, including: single-lever mixer, 2-way diverter and wall spout on a single ultra-flat rectangular plate; shower set on square ultra-flat plate with water connection, holder, brass handshower and 150cm flexible hose.



ET53D2P

Set a incasso a 2 vie per vasca su piastre tonde separate ultra-piatte (3 piastre separate e incasso unico), include: miscelatore monocomando con deviatore a 2 uscite, bocca a muro; set doccia su piastra tonda ultra-piatta con presa acqua, supporto, doccetta e flessibile 150cm.
2-way built-in set for bathtub on separate ultra-flat round plates (3 separate plates, one single built-in part), including: single-lever mixer, 2-way diverter, wall spout; Shower set on ultra-flat round plate with water connection, holder, hand shower and 150cm flexible hose.



ET54D2

Set miscelatore a incasso a 2 vie per vasca/doccia su piastra unica rettangolare ultra-piatta, include miscelatore monocomando, deviatore a 2 uscite, bocca a muro. Da completare con la seconda uscita.
2-way built-in mixer set for bathtub / shower on single ultra-flat rectangular plate, including single-lever mixer, 2-way diverter, wall spout. To be completed with the second water outlet.



ET54D2P

Set miscelatore a incasso a 2 vie per vasca/doccia su 3 piastre tonde ultra-piatte (piastre separate e incasso unico), include: miscelatore monocomando, deviatore a 2 uscite, bocca a muro. Da completare con la seconda uscita acqua.
2-way built-in mixer set for bathtub / shower on 3 ultra-flat round plates (separate plates, one single built-in part), including: single-lever mixer, 2-way diverter, wall spout. To be completed with the second water outlet.

3 VIE - 3-WAY



ET54D3

Set miscelatore a incasso a 3 vie per vasca/doccia su piastra unica rettangolare ultra-piatta, include miscelatore monocomando, deviatore a 3 uscite, bocca a muro. Da completare con la seconda e la terza uscita acqua.
3-way built-in mixer set for bathtub / shower on single ultra-flat rectangular plate, including single-lever mixer, 3-way diverter, wall spout. To be completed with the second and the third water outlets.



ET54D3P

Set miscelatore a incasso a 3 vie per vasca/doccia su 3 piastre tonde ultra-piatte (piastre separate e incasso unico), include: miscelatore monocomando, deviatore a 3 uscite, bocca a muro. Da completare con la seconda e la terza uscita acqua.
3-way built-in mixer set for bathtub / shower on 3 separate round plates (separate plates, one single built-in part), including: single-lever mixer, 3-way diverter, wall spout. To be completed with the second and the third water outlets.

INCASSI DOCCIA - BUILT-IN MIXERS

1 VIA - 1-WAY
**ET30L**

Miscelatore a incasso per doccia, su piastra tonda ultra-piatta.
Built-in shower mixer, ultra-flat round wall flange.

**ET30Q**

Miscelatore a incasso per doccia, su piastra tonda ultra-piatta.
Built-in shower mixer, ultra-flat square wall flange.

2 VIE - 2-WAY
**ET09L**

Miscelatore a incasso per vasca/doccia con deviatore a pressione, su piastra tonda ultra-piatta.
Built-in bath/shower mixer with push button diverter, on ultra-flat round wall flange.

**ET09Q**

Miscelatore a incasso per vasca/doccia con deviatore a pressione, su piastra quadrata ultra-piatta.
Built-in bath/shower mixer with push button diverter, on ultra-flat square wall flange.

**ET09H**

Miscelatore a incasso per vasca/doccia con deviatore a 2 vie a vitone ceramico, su piastra tonda. Per selezionare l'uscita desiderata, la manopola del deviatore deve essere ruotata da una posizione all'altra.
Built-in bath/shower mixer with 2-way diverter with ceramic head valve, on round wall flange. To select the desired output, the diverter knob must be turned from one position to the other.

**ET09HG**

Miscelatore a incasso per vasca/doccia con deviatore a 2 vie a vitone ceramico, su piastra rettangolare. Per selezionare l'uscita desiderata, la manopola del deviatore deve essere ruotata da una posizione all'altra.
Built-in bath/shower mixer with 2-way diverter with ceramic head valve, on rectangular wall flange. To select the desired output, the diverter knob must be turned from one position to the other.



ET09HRG

Miscelatore a incasso per vasca/doccia con deviatore a 2 vie con vitone ceramico, su piastra rettangolare, montaggio orizzontale. Per selezionare l'uscita desiderata, la manopola del deviatore deve essere ruotata da una posizione all'altra.

Built-in bath/shower mixer with 2-way diverter with ceramic head valve, on rectangular plate, horizontal mounting. To select the desired output, the diverter knob must be turned from one position to the other.



ET92R

Miscelatore a incasso per vasca/doccia con deviatore a 2 vie di tipo meccanico. Piastra rettangolare ultra piatta, installazione orizzontale. Per selezionare l'uscita desiderata, posizionare la manopola del deviatore sulla posizione corrispondente.

Built-in bath/shower mixer with 2-way mechanical diverter. Ultra-flat rectangular plate, horizontal mounting. To select the desired water outlet, turn the diverter knob to the corresponding position.



ET92RP

Miscelatore a incasso per vasca/doccia con deviatore a 2 vie di tipo meccanico. Due piastre tonde ultra piatte. Parte a incasso unica, installazione orizzontale. Per selezionare l'uscita desiderata, posizionare la manopola del deviatore sulla posizione corrispondente.

Built-in bath/shower mixer with 2-way mechanical diverter. Two ultra-flat round plates. Single built-in part, horizontal mounting. To select the desired water outlet, turn the diverter knob to the corresponding position.



ET97D2P

Set miscelatore a incasso a 2 vie per vasca/doccia su 3 piastre tonde ultra-piatte (parte a incasso unica), include: miscelatore, deviatore a 2 uscite, presa acqua con supporto, doccetta in ottone e flessibile 150 cm. Da completare con la seconda uscita.

2-way built-in shower mixer set on 3 ultra-flat round plates (single built-in part), including: mixer, 2-way diverter, water connection with holder, brass hand shower and 150cm flexible hose. To be completed with the second water outlet.

iochia Ent



ET97D2Q

Set miscelatore a incasso a 2 vie per vasca/doccia su piastra rettangolare ultra-piatta, include: miscelatore, deviatore a 2 uscite, presa acqua con supporto, doccetta in ottone e flessibile 150 cm. Da completare con la seconda uscita.

2-way built-in shower mixer set on ultra-flat rectangular plate, including: mixer, 2-way diverter, water connection with holder, brass hand shower and 150cm flexible hose. To be completed with the second water outlet.

iochia Ent

3 VIE - 3-WAY



REMER

ET93R

Miscelatore a incasso per vasca/doccia con deviatore a 3 vie di tipo meccanico. Piastra rettangolare ultra piatta, installazione orizzontale. Per selezionare l'uscita desiderata, posizionare la manopola del deviatore sulla posizione corrispondente.

Built-in bath/shower mixer with 3-way mechanical diverter. Ultra-flat rectangular plate, horizontal mounting. To select the desired water outlet, turn the diverter knob to the corresponding position.



REMER

ET93RP

Miscelatore a incasso per vasca/doccia con deviatore a 2 vie di tipo meccanico. Due piastre tonde ultra piatte. Parte a incasso unica, installazione orizzontale. Per selezionare l'uscita desiderata, posizionare la manopola del deviatore sulla posizione corrispondente.

Built-in bath/shower mixer with 2-way mechanical diverter. Two ultra-flat round plates. Single built-in part, horizontal mounting. To select the desired water outlet, turn the diverter knob to the corresponding position.



REMER

ET97D3P

Set miscelatore a incasso a 3 vie per vasca/doccia su 3 piastre tonde ultra-piatte (parte a incasso unica), include: miscelatore, deviatore a 3 uscite, presa acqua con supporto, doccetta in ottone e flessibile 150 cm. Da completare con la seconda e la terza uscita acqua.

3-way built-in bath/shower mixer set on 3 ultra-flat round plates (single built-in part), including: mixer, 3-way diverter, water connection with holder, brass hand shower and 150cm flexible hose. To be completed with the second and the third water outlets.



REMER

ET97D3Q

Set miscelatore a incasso a 3 vie per vasca/doccia su piastra rettangolare ultra-piatta, include: miscelatore, deviatore a 3 uscite, presa acqua con supporto, doccetta in ottone e flessibile 150 cm. Da completare con la seconda e la terza uscita acqua.

3-way built-in shower mixer set on ultra-flat rectangular plate, including: mixer, 3-way diverter, water connection with holder, brass hand shower and 150cm flexible hose. To be completed with the second and the third water outlets.

SLASH & DOT



Le collezioni SLASH & DOT sono due soluzioni complete di rubinetteria per bagno e cucina che condividono un design moderno e compatto. Il corpo tondo del miscelatore si sviluppa su una cartuccia diametro 35mm e si collega tramite una morbida curvatura ad una bocca dalle superfici piatte e dai bordi smussati.

La leva nella versione SLASH presenta un'inclinazione fissa di 11° che differenzia questa collezione da ogni altra proposta a catalogo e che dona ai miscelatori uno stile esclusivo e moderno. La leva DOT elimina invece la bacchetta di miscelazione, accentuando la continuità del design e conferendo all'intera collezione un'eleganza più minimalista.

Collezione disponibile da: Luglio 2023

The SLASH & DOT collections are two complete faucet solutions for bathroom and kitchen that share a modern and compact design. The round body of the mixer is developed on a 35mm diameter cartridge and is connected by a soft curvature to a spout with flat surfaces and rounded edges.

The lever in the SLASH version has a fixed inclination of 11° which differentiates this collection from any other proposal in the catalog and which gives the mixers an exclusive and modern style. The DOT lever instead eliminates the mixing rod, accentuating the continuity of the design and giving the entire collection a more minimalist elegance.

Collection available from: July 2023

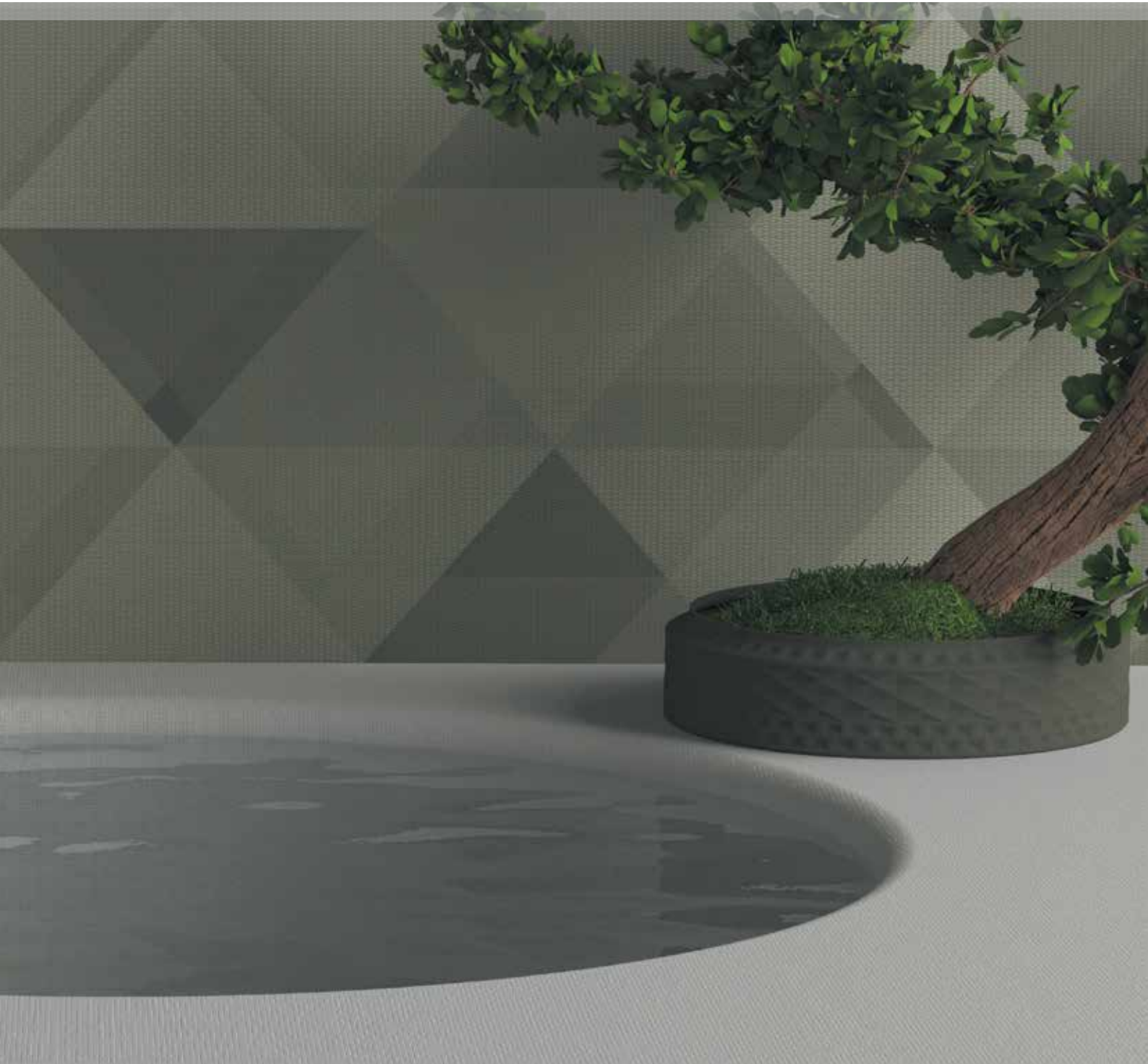



SLASH & DOT

OPZIONI DI FINITURA

Questa collezione di rubinetteria è disponibile in diversi colori di finitura, scegli il colore perfetto per il tuo progetto di arredo!

Per confermare la propria scelta, aggiungere il codice della finitura al termine del codice prodotto al momento dell'ordine.

SLASH & DOT

FINISHING OPTIONS

This faucet collection is available in different finishing colours, choose the perfect one for your interior!



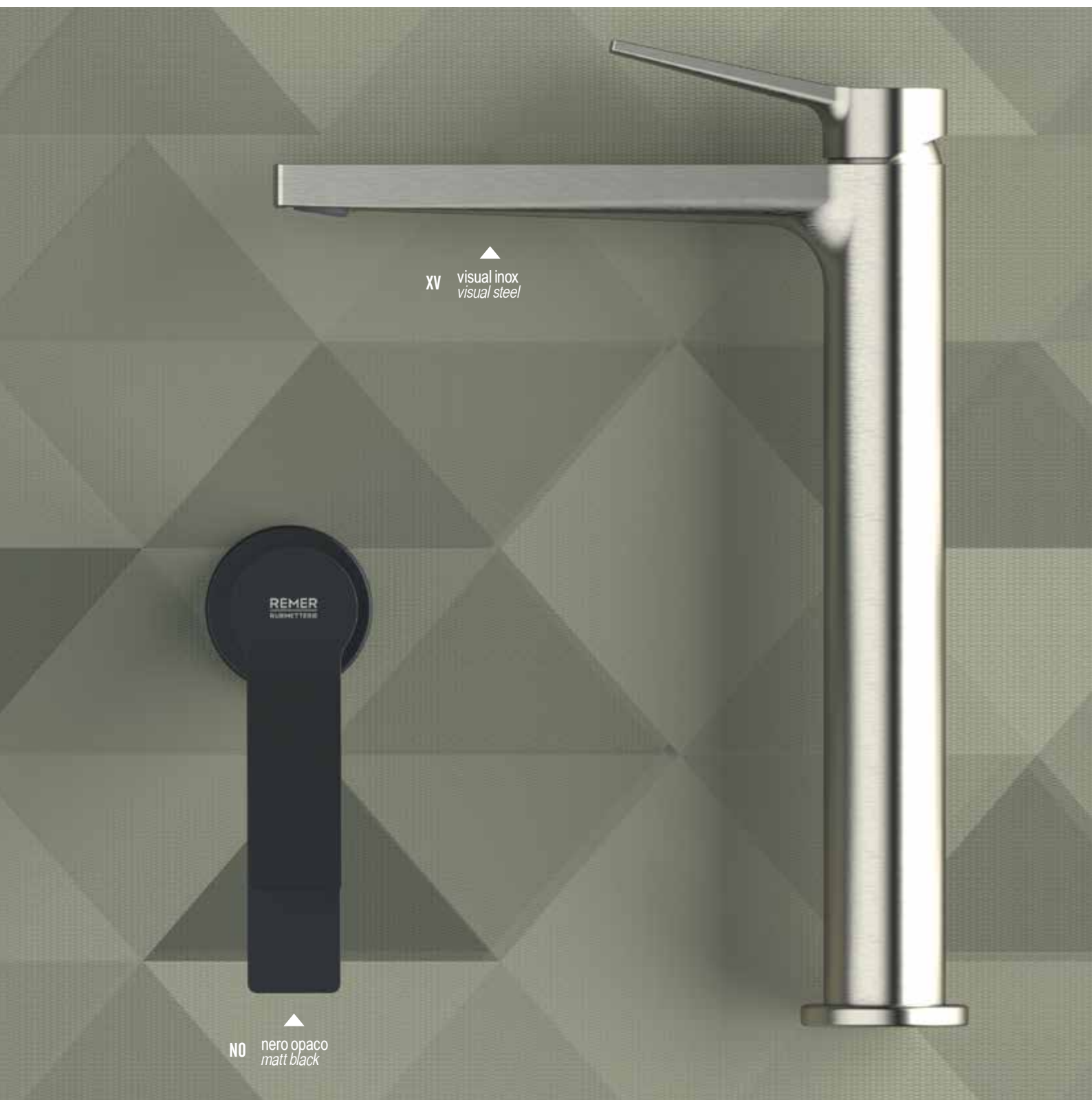

To confirm your choice, add the finish code at the end of the product code when placing your order



▲
XV visual inox
visual steel

▲
NO nero opaco
matt black

CR	
	cromo chrome
	CR

FIN 1		
	nero opaco matt black	NO
	bianco opaco matt white	BO
	nichel spazzolato brushed nickel	NP
	visual inox visual steel	XV

FIN 2		
	oro spazzolato brushed gold	BG
	oro lucido shiny gold	DO

OPZIONE LEVA - LEVER OPTION

La collezione è disponibile con due varianti di maniglia, identificate dalle prime due lettere del codice prodotto. Indicare la preferenza al momento dell'ordine.

This collection is available with two lever options, identified by the first two letters of the product code. Show your preference when ordering.



MISCELATORI LAVABO - WASHBASIN MIXERS



SL10
Miscelatore monocomando per lavabo, con scarico.
Single-lever basin mixer, with pop-up waste.



SL10L
Miscelatore monocomando alto per lavabo, scarico click-clack con troppopieno incluso.
High single-lever basin mixer, click-clack waste with overflow included.



SL57
Miscelatore monocomando per lavabo a due fori. Scarico non incluso.
2-hole single-lever basin mixer. Waste not included.



SL12
Miscelatore monocomando per lavabo, senza scarico e senza foro posteriore sul corpo.
Single-lever basin mixer, without waste and without rear body hole.



SL11L
Miscelatore monocomando alto per lavabo, senza scarico.
High single-lever basin mixer, without waste.



SL57L
Miscelatore monocomando per lavabo a due fori, con bocca L. Scarico non incluso.
2-hole single-lever basin mixer, with L spout. Waste not included.

MISCELATORI PER LAVABO A INCASSO - BUILT-IN WASHBASIN MIXER

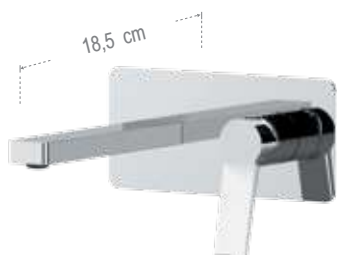

SL15

Miscelatore monocomando a incasso per lavabo. Piastra ultra-piatta. Lunghezza bocca 18,5 cm

Single-lever built-in basin mixer. Ultra-flat flange. Spout length 18,5 cm.

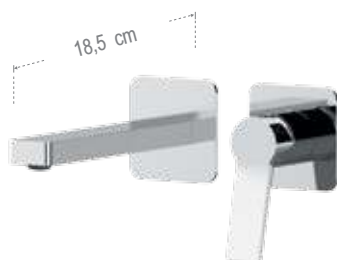

SL15P

Miscelatore monocomando a incasso per lavabo, su due piastre tonde separate. Lunghezza bocca 18,5 cm.

Built-in single-lever basin mixer with two separate round plates. Spout length 18,5 cm.



SL15KB

Miscelatore monocomando a incasso per lavabo da abbinare al box incasso. Piastra ultra-piatta. Lunghezza bocca 18,5 cm.

Single-lever built-in basin mixer, with ultra-flat wall flange. To match with the built-in box. Spout length 18,5 cm.

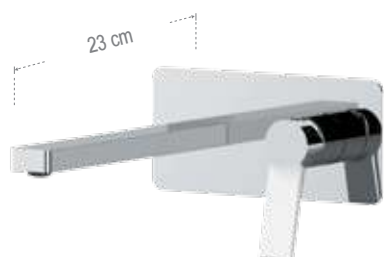

SL15L

Miscelatore monocomando a incasso per lavabo. Piastra ultra-piatta. Lunghezza bocca 23 cm.

Single-lever built-in basin mixer. Ultra-flat flange. Spout length 23 cm.

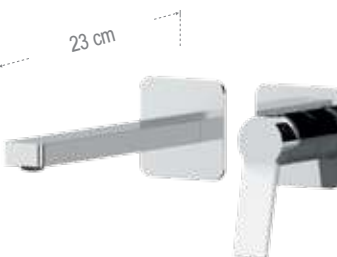

SL15PL

Miscelatore monocomando a incasso per lavabo, su due piastre tonde separate. Lunghezza bocca 23 cm.

Built-in single-lever basin mixer with two separate round plates. Spout length 23 cm.

SL15LKB

Lunghezza bocca 23cm.
Spout length 23cm.



RRBOX15

Box da incasso per miscelatore monocomando a incasso per lavabo.

Built-in box for single-lever built-in basin mixer.

MISCELATORI PER BIDET - BIDET MIXERS



SL20

Miscelatore monocomando per bidet, con scarico.

Single-lever bidet mixer, with pop-up waste.



SL22

Miscelatore monocomando per bidet, senza scarico e senza foro posteriore sul corpo.

Single-lever bidet mixer, without waste and without rear body hole.



SL65W

Set shut-off comprensivo di: miscelatore a incasso con supporto doccia/presa acqua, doccetta a pulsante 332OW, tutto in ottone. Flessibile doccia cm 120.

Shut-off set including: built-in mixer with shower holder/water punch on flange, shut-off hand shower 332OW, all in brass. Flexible hose cm 120.

MISCELATORI PER VASCA E DOCCIA - SHOWER AND BATH MIXERS



SL02

Miscelatore monocomando per vasca, doccetta a 3 funzioni in abs con pulsante per la selezione dei getti, supporto a muro snodato. Flessibile 150cm.

Single-lever bath mixer, 3-function handshower in abs with jet selection button, wall adjustable shower holder. Flexible hose 150cm.



SLC31REW

Miscelatore monocomando esterno per doccia, interasse 100 mm, con doccetta shut-off e flessibile cm 120.

Wall mounted single lever shower mixer, interaxis 100 mm, including shut-off and flexible hose cm 120.



SL38

Miscelatore doccia con leva frontale, doccetta a 3 funzioni in abs con pulsante per la selezione dei getti, supporto doccetta a muro. Flessibile 150cm.

Exposed shower mixer with frontal lever, 3-function handshower in abs with jet selection button, wall shower holder. Flexible hose 150cm.

SL05

Miscelatore monocomando per vasca con deviatore, senza kit doccia.

Wall mounted single-lever bath mixer with diverter, without shower kit.

SLC31

Miscelatore monocomando esterno per doccia, interasse 100 mm, senza kit doccia.

Wall mounted single lever shower mixer, interaxis 100 mm, without shower kit.

SL33

Miscelatore doccia con leva frontale, senza kit doccia.

Exposed shower mixer with frontal lever, without shower kit.



SL03

Miscelatore monocomando da appoggio per vasca, con deviatore, doccetta a 3 funzioni in abs con pulsante per la selezione dei getti, supporto a muro snodato. Flessibile 150cm.

Single lever bath mixer with diverter, 3-function handshower in abs with jet selection button, adjustable wall shower holder. Flexible hose 150cm.



SL04

Miscelatore monocomando per vasca, con deviatore, senza kit doccia.

Single lever bath mixer with diverter, without shower kit.

BOCCHE - SPOUT

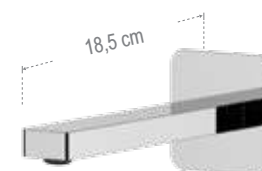

91SL

Bocca a incasso. Lunghezza bocca: 18,5 cm.

Built-in spout. Spout length: 18,5 cm

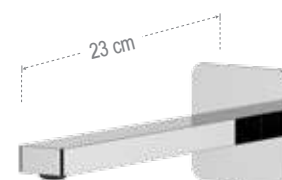

91SLL

Bocca a incasso. Lunghezza bocca: 23 cm.

Built-in spout. Spout length: 23 cm

2 VIE - 2-WAY



SL53D2

Set a incasso a 2 vie per vasca, include: miscelatore monocomando, deviatore a 2 uscite e bocca a muro su piastra unica rettangolare ultra-piatta; set doccia su piastra quadrata ultra-piatta con presa acqua, supporto integrato, doccetta in ottone e flessibile 150cm.

2-way built-in set for bathtub, including: single-lever mixer, 2-way diverter and wall spout on a single ultra-flat rectangular plate; shower set on square ultra-flat plate with water connection, holder, brass handshower and 150cm flexible hose.



SL53D2P

Set a incasso a 2 vie per vasca su piastre tonde separate ultra-piatte (3 piastre separate e incasso unico), include: miscelatore monocomando con deviatore a 2 uscite, bocca a muro; set doccia su piastra tonda ultra-piatta con presa acqua, supporto, doccetta e flessibile 150cm.

2-way built-in set for bathtub on separate ultra-flat round plates (3 separate plates, one single built-in part), including: single-lever mixer, 2-way diverter, wall spout; Shower set on ultra-flat round plate with water connection, holder, hand shower and 150cm flexible hose.



SL54D2

Set miscelatore a incasso a 2 vie per vasca/doccia su piastra unica rettangolare ultra-piatta, include miscelatore monocomando, deviatore a 2 uscite, bocca a muro. Da completare con la seconda uscita.

2-way built-in mixer set for bathtub / shower on single ultra-flat rectangular plate, including single-lever mixer, 2-way diverter, wall spout. To be completed with the second water outlet.



SL54D2P

Set miscelatore a incasso a 2 vie per vasca/doccia su 3 piastre tonde ultra-piatte (piastre separate e incasso unico), include: miscelatore monocomando, deviatore a 2 uscite, bocca a muro. Da completare con la seconda uscita acqua.

2-way built-in mixer set for bathtub / shower on 3 ultra-flat round plates (separate plates, one single built-in part), including: single-lever mixer, 2-way diverter, wall spout. To be completed with the second water outlet.

3 VIE - 3-WAY



SL54D3

Set miscelatore a incasso a 3 vie per vasca/doccia su piastra unica rettangolare ultra-piatta, include miscelatore monocomando, deviatore a 3 uscite, bocca a muro. Da completare con la seconda e la terza uscita acqua.

3-way built-in mixer set for bathtub / shower on single ultra-flat rectangular plate, including single-lever mixer, 3-way diverter, wall spout. To be completed with the second and the third water outlets.



SL54D3P

Set miscelatore a incasso a 3 vie per vasca/doccia su 3 piastre tonde ultra-piatte (piastre separate e incasso unico), include: miscelatore monocomando, deviatore a 3 uscite, bocca a muro. Da completare con la seconda e la terza uscita acqua.

3-way built-in mixer set for bathtub / shower on 3 separate round plates (separate plates, one single built-in part), including: single-lever mixer, 3-way diverter, wall spout. To be completed with the second and the third water outlets.

MISCELATORI AD INCASSO PER DOCCIA - BUILT-IN SHOWER MIXERS

1 VIA - 1-WAY



SL30
Miscelatore incasso per doccia su piastra tonda.
Built-in shower mixer on round plate.



SL30G
Miscelatore incasso per doccia su piastra rettangolare.
Built-in shower mixer on rectangular flange.



SL30L
Miscelatore incasso per doccia su piastra lusso ultrapiatta.
Built-in shower mixer on luxury ultraslim plate.

2 VIE - 2-WAY



SL09
Miscelatore incasso con deviatore a pressione per vasca/doccia su piastra tonda.
Built-in bath/shower mixer with push button diverter on round plate.



SL09G
Miscelatore incasso con deviatore a pressione per vasca/doccia su piastra rettangolare.
Built-in bath/shower mixer with push button diverter on rectangular plate.



SL09L
Miscelatore incasso con deviatore a pressione per vasca/doccia su piastra rettangolare ultra piatta.
Built-in bath/shower mixer with push button diverter on ultra-flat rectangular plate.



SL09H
Miscelatore a incasso per vasca/doccia con deviatore a 2 vie a vitone ceramico, su piastra tonda. Per selezionare l'uscita desiderata, la manopola del deviatore deve essere ruotata da una posizione all'altra.
Built-in bath/shower mixer with 2-way diverter with ceramic head valve, on round wall flange. To select the desired output, the diverter knob must be turned from one position to the other.



SL09HG
Miscelatore a incasso per vasca/doccia con deviatore a 2 vie a vitone ceramico, su piastra rettangolare. Per selezionare l'uscita desiderata, la manopola del deviatore deve essere ruotata da una posizione all'altra.
Built-in bath/shower mixer with 2-way diverter with ceramic head valve, on rectangular wall flange. To select the desired output, the diverter knob must be turned from one position to the other.



SL09HRG
Miscelatore a incasso per vasca/doccia con deviatore a 2 vie con vitone ceramico, su piastra rettangolare, montaggio orizzontale. Per selezionare l'uscita desiderata, la manopola del deviatore deve essere ruotata da una posizione all'altra.
Built-in bath/shower mixer with 2-way diverter with ceramic head valve, on rectangular plate, horizontal mounting. To select the desired output, the diverter knob must be turned from one position to the other.

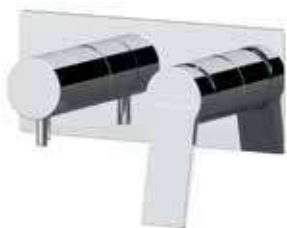

SL92R

Miscelatore a incasso per vasca/doccia con deviatore a 2 vie di tipo meccanico. Piastra rettangolare ultra piatta, installazione orizzontale. Per selezionare l'uscita desiderata, posizionare la manopola del deviatore sulla posizione corrispondente.

Built-in bath/shower mixer with 2-way mechanical diverter. Ultra-flat rectangular plate, horizontal mounting. To select the desired water outlet, turn the diverter knob to the corresponding position.



SL92RP

Miscelatore a incasso per vasca/doccia con deviatore a 2 vie di tipo meccanico. Due piastre tonde ultra piatte. Parte a incasso unica, installazione orizzontale. Per selezionare l'uscita desiderata, posizionare la manopola del deviatore sulla posizione corrispondente.

Built-in bath/shower mixer with 2-way mechanical diverter. Two ultra-flat round plates. Single built-in part, horizontal mounting. To select the desired water outlet, turn the diverter knob to the corresponding position.



SL97D2

Set miscelatore a incasso a 2 vie per vasca/doccia su piastra rettangolare ultra-piatta, include: miscelatore, deviatore a 2 uscite, presa acqua con supporto, doccetta in ottone e flessibile 150 cm. Da completare con la seconda uscita.

2-way built-in shower mixer set on ultra-flat rectangular plate, including: mixer, 2-way diverter, water connection with holder, brass hand shower and 150cm flexible hose. To be completed with the second water outlet.



SL97D2P

Set miscelatore a incasso a 2 vie per vasca/doccia su 3 piastre tonde ultra-piatte (parte a incasso unica), include: miscelatore, deviatore a 2 uscite, presa acqua con supporto, doccetta in ottone e flessibile 150 cm. Da completare con la seconda uscita.

2-way built-in shower mixer set on 3 ultra-flat round plates (single built-in part), including: mixer, 2-way diverter, water connection with holder, brass hand shower and 150cm flexible hose. To be completed with the second water outlet.



3 VIE - 3-WAY

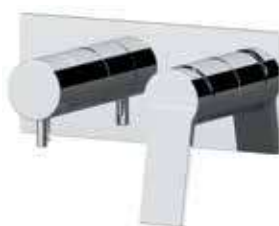

Riservato

SL93R

Miscelatore a incasso per vasca e doccia con deviatore a 3 vie di tipo meccanico. Piastra rettangolare ultra piatta per installazione in orizzontale. Per selezionare l'uscita desiderata, posizionare la manopola del deviatore sulla posizione corrispondente.

Built-in mixer for bath and shower with 3-way mechanical diverter.

Ultra flat rectangular plate for horizontal mounting. To select the desired water outlet, turn the diverter knob to the corresponding position.



Riservato

SL93RP

Miscelatore a incasso per vasca o doccia con deviatore a 3 vie di tipo meccanico. Piastre tonde separate ultra piatte. Parte a incasso unica per installazione in orizzontale. Per selezionare l'uscita desiderata, posizionare la manopola del deviatore sulla posizione corrispondente.

Built-in mixer for bath and shower with 3-way mechanical diverter.

Separate ultra-flat round plates. Single built-in part for horizontal mounting. To select the desired water outlet, turn the diverter knob to the corresponding position.



Riservato

SL97D3

Set miscelatore a incasso a 3 vie per vasca/doccia su piastra rettangolare ultra-piatta, include: miscelatore, deviatore a 3 uscite, presa acqua con supporto, doccetta in ottone e flessibile 150 cm. Da completare con la seconda e la terza uscita acqua.

3-way built-in shower mixer set on ultra-flat rectangular plate, including: mixer, 3-way diverter, water connection with holder, brass hand shower and 150cm flexible hose. To be completed with the second and the third water outlets.



Riservato

SL97D3P

Set miscelatore a incasso a 3 vie per vasca/doccia su 3 piastre tonde ultra-piatte (parte a incasso unica), include: miscelatore, deviatore a 3 uscite, presa acqua con supporto, doccetta in ottone e flessibile 150 cm. Da completare con la seconda e la terza uscita acqua.

3-way built-in bath/shower mixer set on 3 ultra-flat round plates (single built-in part), including: mixer, 3-way diverter, water connection with holder, brass hand shower and 150cm flexible hose. To be completed with the second and the third water outlets.

4/5 VIE - 4/5-WAY



Riservato

SL94

Miscelatore incasso con deviatore a 4 vie per vasca/doccia , 1 entrata e 4 uscite.

Built-in bath/shower mixer with 4-way diverter, 1 inlet and 4 outlets.



Riservato

SL95

Miscelatore incasso con deviatore a 5 vie per vasca/doccia , 1 entrata e 5 uscite.

Built-in bath/shower mixer with 5-way diverter, 1 inlet and 5 outlets.

CUCINA - KITCHEN



Eco
Eco

SL84

Miscelatore monocomando per lavello, con canna alta girevole e sistema di doccetta monofunzione estraibile.

Single-lever sink mixer with high swivel spout and single-function system pull-out hand shower.



ck con T
Eco
Eco

SL84DJ

Miscelatore monocomando per lavello, con canna alta girevole e doccetta estraibile a due funzioni.

Single-lever sink mixer with high swivel spout and 2-functions pull-out hand shower.



ck con T
Eco
Eco

SL81M

Miscelatore monocomando per lavello, con canna alta girevole e doccetta estraibile con impugnatura a martello a due funzioni.

Single-lever sink mixer with high swivel spout and 2-functions pull-out "hammer shaped" handle hand shower.



Eco
Eco

SL42B

Miscelatore monocomando per lavello, con bocca alta girevole.

Single-lever one-hole sink mixer, with high swivel spout.



Eco
Eco

SL72Q

Miscelatore monocomando per lavello, con bocca alta girevole squadrata.

Single lever kitchen mixer with high swivel squared spout



Eco
Eco

SL72U

Miscelatore monocomando monoforo 90°, con canna alta girevole a "U".

Single-lever sink mixer 90°, high swivel "U" spout.



Eco
Eco

SL72

Miscelatore monocomando per lavello, con bocca alta girevole.

Single-lever one-hole sink mixer, with high swivel spout.



Eco
Eco

SL72C

Miscelatore monocomando lavabo/lavello senza scarico, con canna corta girevole, tipo lusso.

Single-lever basin/sink mixer without waste, with short swivel spout, luxury type.

2023

**NEWS WELLNESS
WELLNESS NEWS**



MISCELATORI A INCASSO BUILT-IN MIXERS

PAG 36

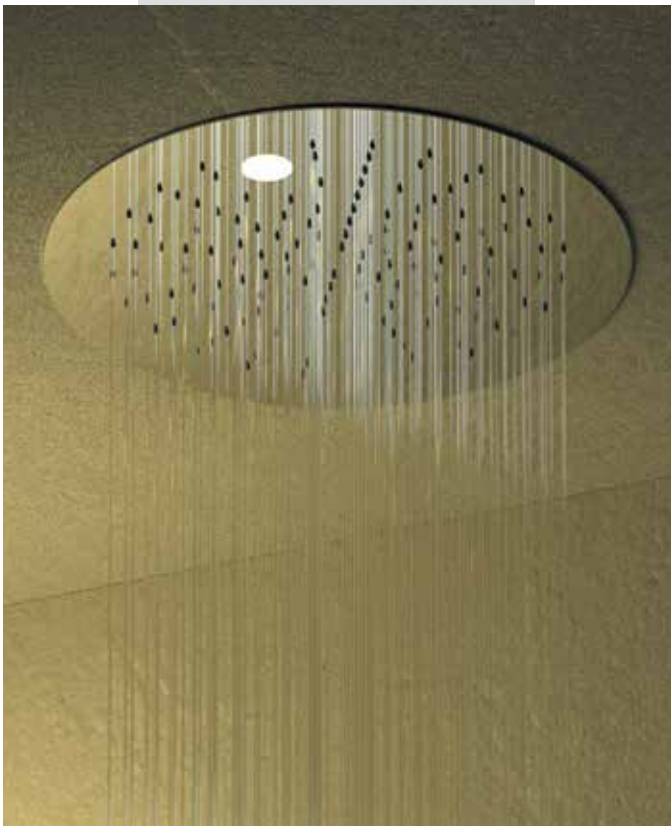

SOFFIONI SHOWER HEAD

PAG 52



SHUT-OFF

PAG 56

NUOVI MISCELATORI A INCASSO PER VASCA E DOCCIA NEW BUILT-IN MIXERS FOR BATH AND SHOWER

Nuove opzioni di miscelatori a incasso si aggiungono ai modelli più tradizionali già disponibili nel catalogo generale Remer, aumentando le prestazioni e la creatività progettuale per le aree del bagno dedicate a doccia e vasca.

New built-in mixer options added to the more traditional models already available in the Remer general catalogue, increasing performance and design creativity in the areas dedicated to the shower and bathtub.

MISCELATORI A 2 VIE CON DEVIATORE CERAMICO - 2-WAY MIXER WITH CERAMIC DIVERTER

I modelli di miscelatore a incasso per vasca o doccia che includono 09H nel codice prodotto utilizzano un deviatore a 2 vie con vitone ceramico. Per selezionare l'uscita desiderata, la manopola del deviatore deve essere ruotata da una posizione all'altra.

Built-in bath or shower mixers that include 09H in the product code use a 2-way diverter with ceramic head valve. To select the desired output, the diverter knob must be turned from one position to the other.

Con piastra tonda <i>With round plate</i>	09H
Con piastra rettangolare verticale <i>With rectangular vertical plate</i>	09HG
Con piastra rettangolare orizzontale <i>With rectangular horizontal plate</i>	09HRG

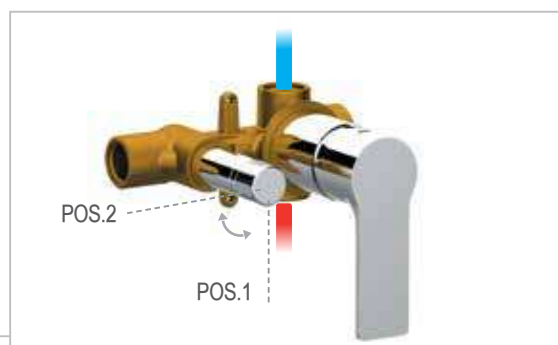

MISCELATORI A 2 O 3 VIE CON DEVIATORE MECCANICO - 2 OR 3-WAY MIXERS WITH MECHANICAL DIVERTER

I modelli di miscelatore a incasso per vasca o doccia che includono 92R o 93R nel codice prodotto utilizzano un deviatore meccanico in linea orizzontale. A seconda del modello scelto, si possono gestire 2 oppure 3 uscite acqua. Per selezionare l'uscita desiderata, posizionare la manopola del deviatore sulla posizione corrispondente.

Built-in bath or shower mixers that include 92R or 93R in the part number use a horizontally positioned mechanical diverter. Depending on the model chosen, 2 or 3 water outlets can be managed. To select the desired water outlet, turn the diverter knob to the corresponding position.

Con piastra orizzontale - <i>With horizontal plate</i>	92R/93R
Con piastre tonde separate - <i>With separate round plates</i>	92RP/93RP

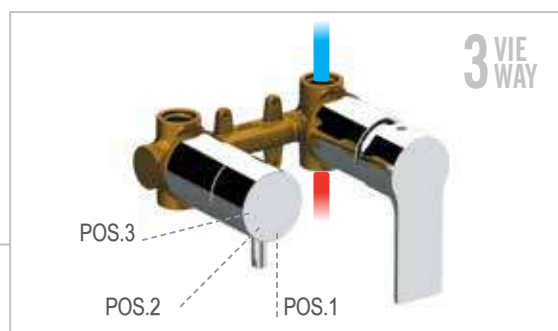
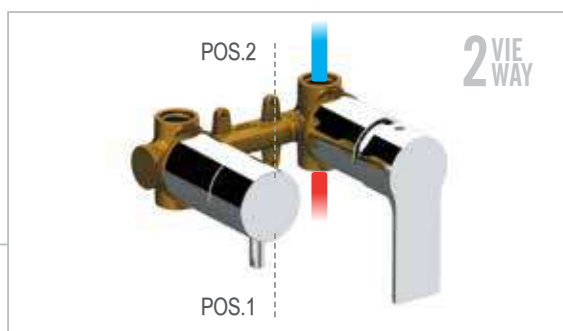

MISCELATORI A 2 O 3 VIE CON DOCCETTA INTEGRATA - 2 OR 3-WAY MIXERS WITH HAND SHOWER

Questi miscelatori a incasso per vasca o doccia utilizzano un deviatore meccanico a scelta tra 2 o 3 vie. La parte a incasso è un corpo unico che collega miscelatore, deviatore e la presa acqua del kit doccia. Da completare con una seconda uscita acqua (ed una terza uscita a seconda del modello): ad esempio soffione, getti o bocca a incasso.

These built-in bath and shower mixers use a mechanical diverter for 2 or 3 outlets. The built-in part is a single block for mixer, diverter and the hand shower kit. To be completed with a second water outlet (and third one depending on model): E.g. shower head, body-jets or wall spout.

Con piastra rettangolare - *With rectangular plate*

97D

Con piastre tonde separate - *With separate round plates*

97PD

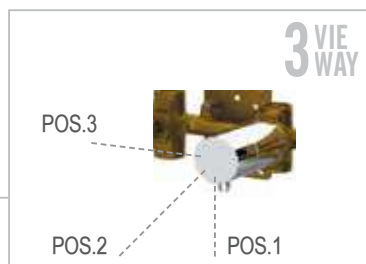

MISCELATORI A 2 O 3 VIE CON BOCCA INTEGRATA - 2/3 WAY MIXERS WITH WALL SPOUT

Questi miscelatori a incasso per vasca e doccia utilizzano un deviatore meccanico a scelta tra 2 o 3 vie. La parte a incasso è un corpo unico che collega miscelatore, deviatore e la bocca a muro. Da completare con una seconda uscita acqua (ed una terza uscita a seconda del modello): ad esempio soffione, getti o doccia.

These built-in bath and shower mixers use a mechanical diverter for 2 or 3 outlets. The built-in part is a single block for mixer, diverter and the wall spout. To be completed with a second water outlet (and third one depending on model): E.g. shower head, body-jets or hand shower.

Con piastra rettangolare - *With rectangular plate*

54D

Con piastre tonde separate - *With separate round plates*

54PD

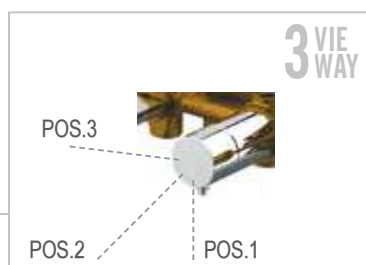
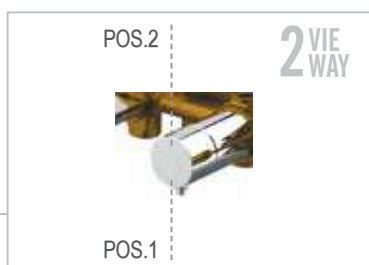

MISCELATORI A 3, 4 O 5 VIE CON VITONE CERAMICO - 3, 4 OR 5-WAY MIXER WITH CERAMIC HEADVALVE

I miscelatori a incasso per vasca o doccia che includono 98D nel codice prodotto permettono di gestire, a seconda del modello, da 3 a 5 uscite acqua tramite deviatori a vitone ceramico dedicati. Per azionare l'uscita desiderata, ruotare la manopola del deviatore corrispondente. Questi modelli prevedono un'unica parte a incasso e possono essere installati sia in orizzontale che in verticale.

The built-in mixers for bath or shower that include 98D in the product code allow you to manage, depending on the model, from 3 to 5 water outlets via dedicated ceramic valve diverters. To activate the desired output, turn the knob of the corresponding outlet. These models have a single built-in part and can be installed both horizontally and vertically.

Con piastra rettangolare
With rectangular plate

98D

Con piastre tonde separate
With separate round plates

98D

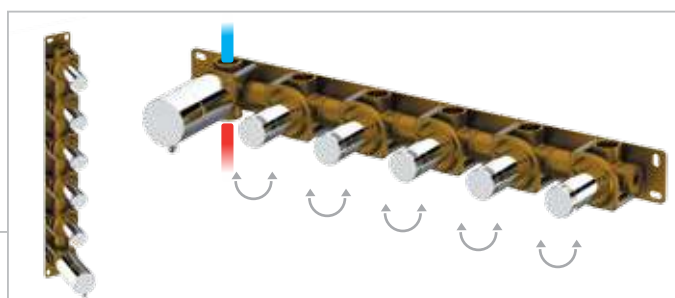

MISCELATORI A 2 VIE CON DEVIATORE CERAMICO - 2-WAY MIXER WITH CERAMIC DIVERTER



CON PIASTRA TONDA
WITH ROUND PLATE

Miscelatore a incasso per vasca o doccia con deviatore a 2 vie con vitone ceramico su piastra tonda. Per selezionare l'uscita desiderata, la manopola del deviatore deve essere ruotata da una posizione all'altra.

Built-in mixer for bath or shower with 2-way diverter with ceramic head valve on round plate. To select the desired output, the diverter knob must be turned from one position to the other.



ELEMENT

ET09H

2 vie 2-way



SLASH

SL09H

2 vie 2-way



DOT

DT09H

2 vie 2-way



X-STYLE

X09H

2 vie 2-way



ENERGY

EY09H

2 vie 2-way



VANITY

V09H

2 vie 2-way



INFINITY

I09H

2 vie 2-way



DREAM

D09H

2 vie 2-way



CLASS LINE

L09H

2 vie 2-way



WINNER

W09H

2 vie 2-way

Disponibili da MAGGIO 2023 - Available from MAY 2023

Disponibili da LUGLIO 2023 - Available from JULY 2023

MISCELATORI A 2 VIE CON DEVIATORE CERAMICO - 2-WAY MIXER WITH CERAMIC DIVERTER



CON PIASTRA RETTANGOLARE VERTICALE
WITH RECTANGULAR VERTICAL PLATE

Miscelatore a incasso per vasca o doccia con deviatore a 2 vie con vitone ceramico, su piastra rettangolare con montaggio verticale. Per selezionare l'uscita desiderata, la manopola del deviatore deve essere ruotata da una posizione all'altra.

Built-in mixer for bath or shower with 2-way diverter with ceramic head valve, on rectangular plate with vertical mounting. To select the desired output, the diverter knob must be turned from one position to the other.



SLASH

SL09HG
2 vie 2-way



DOT

DT09HG
2 vie 2-way



Q DESIGN

QD09HG
2 vie 2-way



ABSOLUTE

AU09HG
2 vie 2-way



ENERGY

EY09HG
2 vie 2-way



VANITY

V09HG
2 vie 2-way



INFINITY

I09HG
2 vie 2-way



DREAM

D09HG
2 vie 2-way



CLASS LINE

L09HG
2 vie 2-way



WINNER

W09HG
2 vie 2-way

Disponibili da MAGGIO 2023 - Available from MAY 2023

Disponibili da LUGLIO 2023 - Available from JULY 2023

MISCELATORI A 2 VIE CON DEVIATORE CERAMICO - MISCELATORI A 2 VIE CON DEVIATORE CERAMICO



CON PIASTRA RETTANGOLARE ORIZZONTALE
WITH RECTANGULAR HORIZONTAL PLATE

Miscelatore a incasso per vasca e doccia con deviatore a 2 vie con vitone ceramico, su piastra rettangolare con montaggio orizzontale. Per selezionare l'uscita desiderata, la manopola del deviatore deve essere ruotata da una posizione all'altra.

Built-in mixer for bath and shower with 2-way diverter with ceramic head valve, on rectangular plate with horizontal mounting. To select the desired output, the diverter knob must be turned from one position to the other.



ELEMENT

ET09HRG
2 vie 2-way



DOT

DT09HRG
2 vie 2-way



Q DESIGN

QD09HRG
2 vie 2-way



ENERGY

EY09HRG
2 vie 2-way



INFINITY

I09HRG
2 vie 2-way



CLASS LINE

L09HRG
2 vie 2-way



SLASH

SL09HRG
2 vie 2-way



X-STYLE

X09HRG
2 vie 2-way



ABSOLUTE

AU09HRG
2 vie 2-way



VANITY

V09HRG
2 vie 2-way



DREAM

D09HRG
2 vie 2-way



WINNER

W09HRG
2 vie 2-way

Disponibili da MAGGIO 2023 - Available from MAY 2023

Disponibili da LUGLIO 2023 - Available from JULY 2023



MISCELATORI A 2 O 3 VIE CON DEVIATORE MECCANICO - 2 OR 3-WAY MIXERS WITH MECHANICAL DIVERTER



CON PIASTRA RETTANGOLARE
WITH RECTANGULAR PLATE

Miscelatore a incasso per vasca e doccia con deviatore a 2 o 3 vie di tipo meccanico. Piastra rettangolare ultra piatta per installazione in orizzontale. Per selezionare l'uscita desiderata, posizionare la manopola del deviatore sulla posizione corrispondente.

Built-in mixer for bath and shower with 2 or 3-way mechanical diverter.

Ultra flat rectangular plate for horizontal mounting.

To select the desired water outlet, turn the diverter knob to the corresponding position.



ELEMENT

ET92R

2 vie 2-way

ET93R

3 vie 3-way



SLASH

SL92R

2 vie 2-way

SL93R

3 vie 3-way



DOT

DT92R

2 vie 2-way

DT93R

3 vie 3-way



X-STYLE

X92R

2 vie 2-way

X93R

3 vie 3-way



Q DESIGN

QD92R

2 vie 2-way

QD93R

3 vie 3-way



ABSOLUTE

AU92R

2 vie 2-way

AU93R

3 vie 3-way



ENERGY

EY92R

2 vie 2-way

EY93R

3 vie 3-way



INFINITY

I92R

2 vie 2-way

I93R

3 vie 3-way



CLASS LINE

L92R

2 vie 2-way

L93R

3 vie 3-way



WINNER

W92R

2 vie 2-way

W93R

3 vie 3-way

Disponibili da MAGGIO 2023 - Available from MAY 2023

Disponibili da LUGLIO 2023 - Available from JULY 2023

MISCELATORI A 2 O 3 VIE CON DEVIATORE MECCANICO - 2 OR 3-WAY MIXERS WITH MECHANICAL DIVERTER



CON PIASTRE TONDE SEPARATE
WITH SEPARATE ROUND PLATES

Miscelatore a incasso per vasca o doccia con deviatore a 2 o 3 vie di tipo meccanico. Piastre tonde separate ultra piatte. Parte a incasso unica per installazione in orizzontale. Per selezionare l'uscita desiderata, posizionare la manopola del deviatore sulla posizione corrispondente.

Built-in mixer for bath and shower with 2 or 3-way mechanical diverter. Separate ultra-flat round plates. Single built-in part for horizontal mounting. To select the desired water outlet, turn the diverter knob to the corresponding position.



ELEMENT

ET92RP
2 vie 2-way

ET93RP
3 vie 3-way



SLASH

SL92RP
2 vie 2-way

SL93RP
3 vie 3-way



DOT

DT92RP
2 vie 2-way

DT93RP
3 vie 3-way



X-STYLE

X92RP
2 vie 2-way

X93RP
3 vie 3-way



ENERGY

EY92RP
2 vie 2-way

EY93RP
3 vie 3-way



INFINITY

I92RP
2 vie 2-way

I93RP
3 vie 3-way



CLASS LINE

L92RP
2 vie 2-way

L93RP
3 vie 3-way



WINNER

W92RP
2 vie 2-way

W93RP
3 vie 3-way

Disponibili da MAGGIO 2023 - Available from MAY 2023

Disponibili da LUGLIO 2023 - Available from JULY 2023

MISCELATORI A 2 O 3 VIE CON DOCCETTA INTEGRATA - 2 OR 3-WAY MIXERS WITH HAND SHOWER

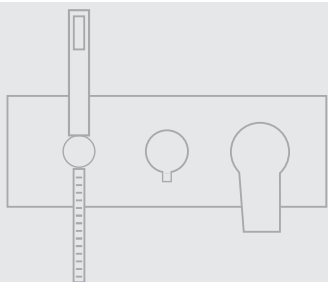

CON PIASTRA RETTANGOLARE
WITH RECTANGULAR PLATE

Miscelatore a incasso per vasca e doccia con deviatore meccanico a 2 o 3 vie e kit doccia in ottone. Piastra rettangolare ultra piatta, parte a incasso unica.

Da completare con una seconda uscita acqua (ed una terza a seconda del modello).

Built-in mixer for bath and shower with 2 or 3-way mechanical diverter and brass hand shower kit. Ultra flat rectangular plate, single built-in part.

To be completed with a second water outlet (and a third one depending on the model).



ELEMENT

ET97D2
2 vie 2-way

ET97D3
3 vie 3-way



SLASH

SL97D2
2 vie 2-way

SL97D3
3 vie 3-way



DOT

DT97D2
2 vie 2-way

DT97D3
3 vie 3-way



X-STYLE

X97D2
2 vie 2-way

X97D3
3 vie 3-way



Q DESIGN

QD97D2
2 vie 2-way

QD97D3
3 vie 3-way



ABSOLUTE

AU97D2
2 vie 2-way

AU97D3
3 vie 3-way



ENERGY

EY97D2
2 vie 2-way

EY97D3
3 vie 3-way



INFINITY

I97D2
2 vie 2-way

I97D3
3 vie 3-way



CLASS LINE

L97D2
2 vie 2-way

L97D3
3 vie 3-way



WINNER

W97D2
2 vie 2-way

W97D3
3 vie 3-way

Disponibili da MAGGIO 2023 - Available from MAY 2023

Disponibili da LUGLIO 2023 - Available from JULY 2023

MISCELATORI A 2 O 3 VIE CON DOCCETTA INTEGRATA - 2 OR 3-WAY MIXERS WITH HAND SHOWER

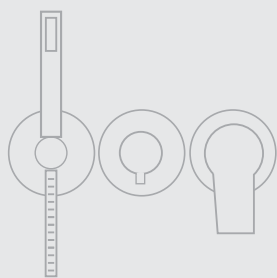

CON PIASTRE TONDE SEPARATE
WITH SEPARATE ROUND PLATES

Miscelatore a incasso per vasca o doccia con deviatore meccanico a 2 o 3 vie e kit doccetta in ottone. Piastre tonde separate ultra piatte, parte a incasso unica.
Da completare con una seconda uscita acqua (ed una terza a seconda del modello).

Built-in mixer for bath or shower with 2 or 3-way mechanical diverter and brass hand shower kit. Separate ultra-flat round plates, single built-in part.

To be completed with a second water outlet (and a third one depending on the model).



ELEMENT

ET97D2P
2 vie 2-way

ET97D3P
3 vie 3-way



SLASH

SL97D2P
2 vie 2-way

SL97D3P
3 vie 3-way



DOT

DT97D2P
2 vie 2-way

DT97D3P
3 vie 3-way



X-STYLE

X97D2P
2 vie 2-way

X97D3P
3 vie 3-way



ENERGY

EY97D2P
2 vie 2-way

EY97D3P
3 vie 3-way



INFINITY

I97D2P
2 vie 2-way

I97D3P
3 vie 3-way



CLASS LINE

L97D2P
2 vie 2-way

L97D3P
3 vie 3-way



WINNER

W97D2P
2 vie 2-way

W97D3P
3 vie 3-way

Disponibili da MAGGIO 2023 - Available from MAY 2023

Disponibili da LUGLIO 2023 - Available from JULY 2023

MISCELATORI A 2 O 3 VIE CON BOCCA INTEGRATA - 2 OR 3-WAY MIXERS WITH WALL SPOUT



CON PIASTRA RETTANGOLARE
WITH RECTANGULAR PLATE

Miscelatore a incasso per vasca e doccia con deviatore meccanico a 2 o 3 vie e bocca a muro. Piastra rettangolare ultra piatta, parte a incasso unica.

Da completare con una seconda uscita acqua (ed una terza a seconda del modello).

Built-in mixer for bath and shower with 2 or 3-way mechanical diverter and wall spout.

Ultra flat rectangular plate, single built-in part.

To be completed with a second water outlet (and a third one depending on the model).



ELEMENT

ET54D2
2 vie 2-way

ET54D3
3 vie 3-way



SLASH

SL54D2
2 vie 2-way

SL54D3
3 vie 3-way



DOT

DT54D2
2 vie 2-way

DT54D3
3 vie 3-way



X-STYLE

X54D2
2 vie 2-way

X54D3
3 vie 3-way



Q DESIGN

QD54D2
2 vie 2-way

QD54D3
3 vie 3-way



ABSOLUTE

AU54D2
2 vie 2-way

AU54D3
3 vie 3-way



ENERGY

EY54D2
2 vie 2-way

EY54D3
3 vie 3-way



INFINITY

I54D2
2 vie 2-way

I54D3
3 vie 3-way



CLASS LINE

L54D2
2 vie 2-way

L54D3
3 vie 3-way



WINNER

W54D2
2 vie 2-way

W54D3
3 vie 3-way

Disponibili da MAGGIO 2023 - Available from MAY 2023

Disponibili da LUGLIO 2023 - Available from JULY 2023

SET MISCELATORI A 2 VIE CON BOCCA INTEGRATA - 2-WAY MIXER SET WITH WALL SPOUT

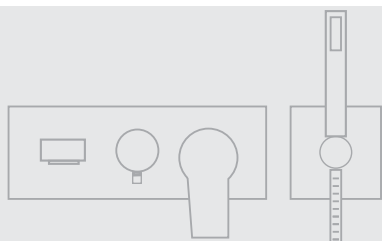

CON PIASTRA RETTANGOLARE E KIT DOCCIA
WITH RECTANGULAR PLATE AND SHOWER KIT

Miscelatore a incasso per vasca e doccia con deviatore meccanico a 2 vie e kit doccetta in ottone. Piastre ultrapiatte, parte a incasso unica per miscelatore, deviatore e bocca. Da completare con una seconda uscita acqua.

Built-in mixer for bath or shower with 2 mechanical diverter and brass hand shower kit. Ultra-flat plates, single built-in part for mixer, diverter and spout. To be completed with a second water outlet.



ELEMENT

ET53D2
2 vie 2-way



SLASH

SL53D2
2 vie 2-way



DOT

DT53D2
2 vie 2-way



X-STYLE

X53D2
2 vie 2-way



Q DESIGN

QD53D2
2 vie 2-way



ABSOLUTE

AU53D2
2 vie 2-way



ENERGY

EY53D2
2 vie 2-way



INFINITY

I53D2
2 vie 2-way



CLASS LINE

L53D2
2 vie 2-way



WINNER

W53D2
2 vie 2-way

Disponibili da MAGGIO 2023 - Available from MAY 2023

Disponibili da LUGLIO 2023 - Available from JULY 2023

MISCELATORI A 2 O 3 VIE CON BOCCA INTEGRATA - 2 OR 3-WAY MIXERS WITH WALL SPOUT



CON PIASTRE TONDE SEPARATE
WITH SEPARATE ROUND PLATES

Miscelatore a incasso per vasca e doccia con deviatore meccanico a 2 o 3 vie e bocca a muro. Piastre tonde separate ultra piatte, parte a incasso unica.

Da completare con una seconda uscita acqua (ed una terza a seconda del modello).

Built-in mixer for bath and shower with 2 or 3-way mechanical diverter and wall spout.

Ultra flat separate round plates, single built-in part.

To be completed with a second water outlet (and a third one depending on the model).



ELEMENT

ET54D2P
2 vie 2-way

ET54D3P
3 vie 3-way



SLASH

SL54D2P
2 vie 2-way

SL54D3P
3 vie 3-way



DOT

DT54D2P
2 vie 2-way

DT54D3P
3 vie 3-way



X-STYLE

X54D2P
2 vie 2-way

X54D3P
3 vie 3-way



ENERGY

EY54D2P
2 vie 2-way

EY54D3P
3 vie 3-way



INFINITY

I54D2P
2 vie 2-way

I54D3P
3 vie 3-way



CLASS LINE

L54D2P
2 vie 2-way

L54D3P
3 vie 3-way



WINNER

W54D2P
2 vie 2-way

W54D3P
3 vie 3-way

Disponibili da MAGGIO 2023 - Available from MAY 2023

Disponibili da LUGLIO 2023 - Available from JULY 2023

SET MISCELATORI A 2 VIE CON BOCCA INTEGRATA - 2-WAY MIXER SET WITH WALL SPOUT

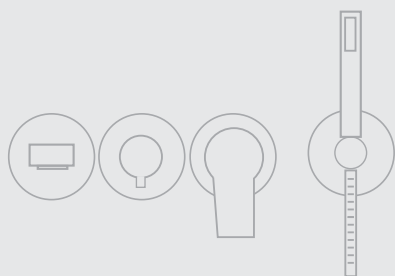

CON PIASTRE TONDE SEPARATE E KIT DOCCIA
WITH SEPARATE ROUND PLATES AND SHOWER KIT

Miscelatore a incasso per vasca e doccia con deviatore meccanico a 2 vie e kit doccia in ottone. Piastre tonde ultrapiatte, parte a incasso unica per miscelatore, deviatore e bocca. Da completare con una seconda uscita acqua.

Built-in mixer for bath or shower with 2 mechanical diverter and brass hand shower kit. Ultra-flat round plates, single built-in part for mixer, diverter and spout. To be completed with a second water outlet.



ELEMENT

ET53D2P
2 vie 2-way



SLASH

SL53D2P
2 vie 2-way



DOT

DT53D2P
2 vie 2-way



X-STYLE

X53D2P
2 vie 2-way



ENERGY

EY53D2P
2 vie 2-way



INFINITY

I53D2P
2 vie 2-way



CLASS LINE

L53D2P
2 vie 2-way



WINNER

W53D2P
2 vie 2-way

Disponibili da MAGGIO 2023 - Available from MAY 2023

Disponibili da LUGLIO 2023 - Available from JULY 2023

MISCELATORI A 3/4/5 VIE CON VITONE CERAMICO - 3, 4 OR 5-WAY MIXER WITH CERAMIC HEADVALVE

Miscelatore a incasso per vasca o doccia con deviatori singoli a vitone ceramico, da 3 a 5 uscite.

Per azionare l'uscita desiderata, ruotare la manopola del deviatore corrispondente. Parte a incasso unica, installazione possibile sia in orizzontale che in verticale.

Built-in mixer for bath or shower with single ceramic valve diverters, from 3 to 5 outlets.

To open the desired water outlet, turn the knob of the corresponding diverter. Single recessed part, installation possible both horizontally and vertically.

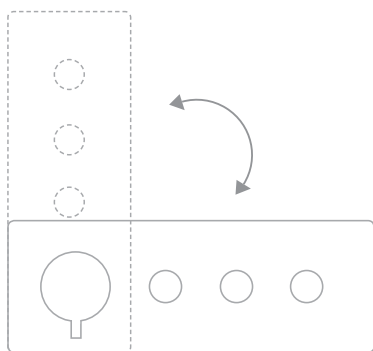

CON PIASTRA RETTANGOLARE
WITH RECTANGULAR PLATE

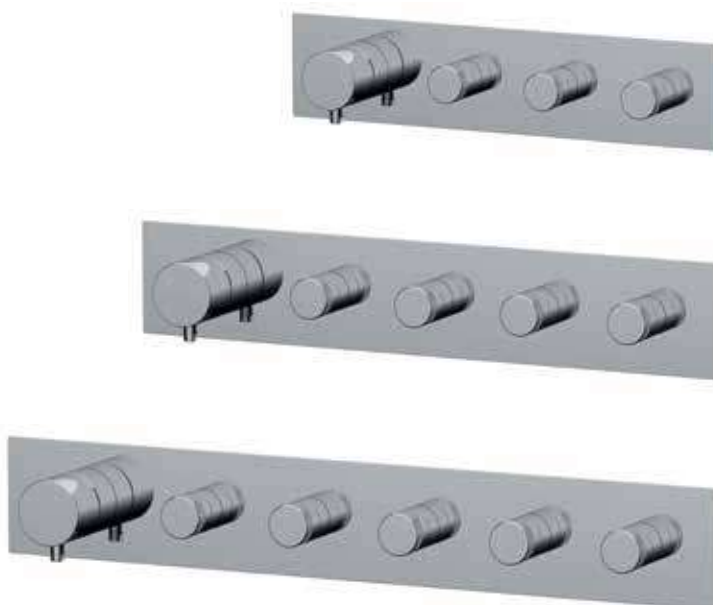

N98D3
3 vie 3-way

N98D4
4 vie 4-way

N98D5
5 vie 5-way

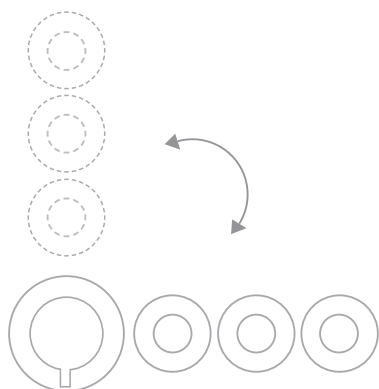

CON PIASTRE TONDE SEPARATE
WITH SEPARATE ROUND PLATES



N98D3P
3 vie 3-way

N98D4P
4 vie 4-way

N98D5P
5 vie 5-way

Disponibili da LUGLIO 2023 - Available from JULY 2023



SOFFIONI A SOFFITTO “EASY FIX” CON FARETTO LED “EASY FIX” CEILING SHOWER HEAD WITH LED POTLIGHT



OVERFLOW

357REFS34

Soffione quadrato a soffitto 34x34 cm con getto a pioggia e faretto per cromoterapia, ispezionabile, acciaio INOX lucidato a specchio. Sistema di montaggio “Easy Fix”. Include pulsantiera a parete per comandi luce.
Square ceiling shower head, 34x34 cm, with rain jet and spotlight for colourtherapy, mirror polished stainless steel. “Easy Fix” mounting system. Wall push-button panel for light controls included.



OVERFLOW

357REFS44

Soffione quadrato a soffitto 44x44 cm con getto a pioggia e faretto per cromoterapia, ispezionabile, acciaio INOX lucidato a specchio. Sistema di montaggio “Easy Fix”. Include pulsantiera a parete per comandi luce.
Square ceiling shower head, 44x44 cm, with rain jet and spotlight for colourtherapy, mirror polished stainless steel. “Easy Fix” mounting system. Wall push-button panel for light controls included.



OVERFLOW

357REFM34

Soffione tondo a soffitto Ø34 cm con getto a pioggia e faretto per cromoterapia, ispezionabile, acciaio INOX lucidato a specchio. Sistema di montaggio “Easy Fix”. Include pulsantiera a parete per comandi luce.
Round ceiling shower head, Ø34 cm, with rain jet and spotlight for colourtherapy, mirror polished stainless steel. “Easy Fix” mounting system. Wall push-button panel for light controls included.

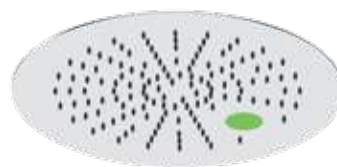

OVERFLOW

357REFM44

Soffione tondo a soffitto Ø44 cm con getto a pioggia e faretto per cromoterapia, ispezionabile, acciaio INOX lucidato a specchio. Sistema di montaggio “Easy Fix”. Include pulsantiera a parete per comandi luce.
Round ceiling shower head, Ø44 cm, with rain jet and spotlight for colourtherapy, mirror polished stainless steel. “Easy Fix” mounting system. Wall push-button panel for light controls included.

2 VIE - 2-WAY



OVERFLOW

357REFM44G

Soffione tondo a soffitto Ø44 cm con due uscite acqua: getto a pioggia e getto singolo centrale. Faretto per cromoterapia, ispezionabile, acciaio INOX lucidato a specchio. Sistema di montaggio “Easy Fix”. Include pulsantiera a parete per comandi luce.
Round ceiling shower head, Ø44 cm, with 2 water outlets: rain jet and central single jet. Spotlight for colourtherapy, mirror polished stainless steel. “Easy Fix” mounting system. Wall push-button panel for light controls included.



OVERFLOW

357REFS44G

Soffione quadrato a soffitto 44x44 cm con due uscite acqua: getto a pioggia e getto singolo centrale. Faretto per cromoterapia, ispezionabile, acciaio INOX lucidato a specchio. Sistema di montaggio “Easy Fix”. Include pulsantiera a parete per comandi luce.
Square ceiling shower head, 44x44 cm, with 2 water outlets: rain jet and central single jet. Spotlight for colourtherapy, mirror polished stainless steel. “Easy Fix” mounting system. Wall push-button panel for light controls included.

PULSANTIERA CON INSTALLAZIONE A PARETE IN DOTAZIONE AL PRODOTTO:
 WALL MOUNTING PUSH-BUTTON PANEL SUPPLIED WITH THE PRODUCT:

Gestione delle funzioni di cromoterapia:

- Prima pressione: ACCESO
- Pressioni successive: scelta manuale del colore
- Pressione prolungata (2 secondi): rotazione automatica dei colori
- 2 pressioni consecutive: SPENTO
- Sequenza colori LED RGB:
- Bianco - Rosso - Verde - Blu - Giallo - Fucsia – Azzurro

Colour therapy functions control:

- *First button press: POWER ON*
- *Subsequent button presses: manual colour selection*
- *Long press (2 seconds): automatic colour rotation*
- *2 consecutive button presses: POWER OFF*
- *RGB LED Colour sequence:*
- *White - Red - Green - Blue - Yellow - Fuchsia - Bright Blue*

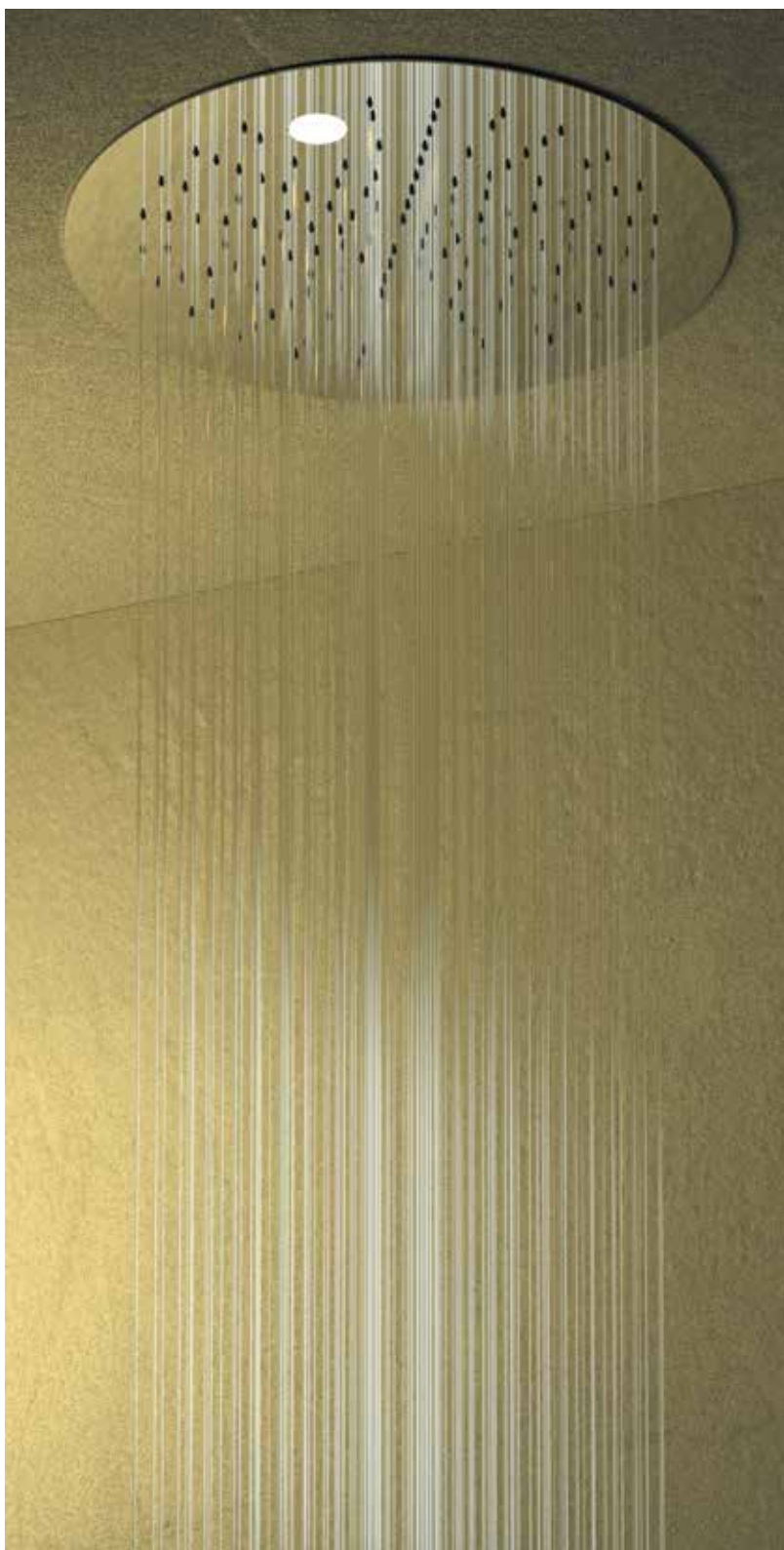

2 VIE - 2-WAY



357EFM34G

Soffione tondo a soffitto Ø34 cm con due uscite acqua: getto a pioggia e getto singolo centrale. Ispezionabile. Acciaio INOX lucidato a specchio. Sistema di montaggio "Easy Fix".

Round ceiling shower head, Ø34 cm, with 2 water outlets: rain jet and central single jet. Mirror polished stainless steel. "Easy Fix" mounting system.

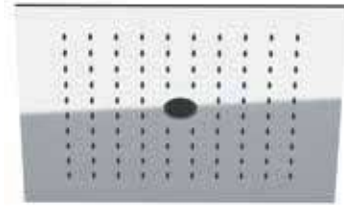

357EFS34G

Soffione tondo a soffitto 34x34 cm con due uscite acqua: getto a pioggia e getto singolo centrale. Ispezionabile. Acciaio INOX lucidato a specchio. Sistema di montaggio "Easy Fix".

Round ceiling shower head, 34x34 cm, with 2 water outlets: rain jet and central single jet. Mirror polished stainless steel. "Easy Fix" mounting system.

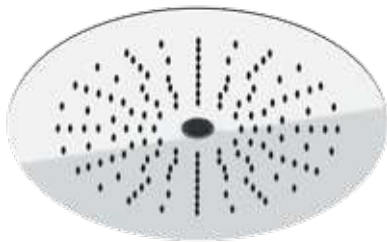

357EFM44G

Soffione tondo a soffitto Ø44 cm con due uscite acqua: getto a pioggia e getto singolo centrale. Ispezionabile. Acciaio INOX lucidato a specchio. Sistema di montaggio "Easy Fix".

Round ceiling shower head, Ø44 cm, with 2 water outlets: rain jet and central single jet. Mirror polished stainless steel. "Easy Fix" mounting system.

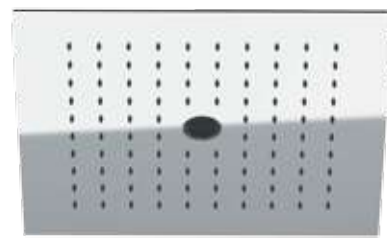

357EFS44G

Soffione tondo a soffitto 44x44 cm con due uscite acqua: getto a pioggia e getto singolo centrale. Ispezionabile. Acciaio INOX lucidato a specchio. Sistema di montaggio "Easy Fix".

Round ceiling shower head, 44x44 cm, with 2 water outlets: rain jet and central single jet. Mirror polished stainless steel. "Easy Fix" mounting system.

APPLICAZIONE A SOFFITTO "EASY FIX" - "EASY FIX" CEILING APPLICATION

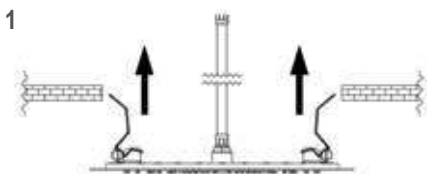

Per questa tipologia di soffione e con questo specifico sistema di fissaggio sono previste quattro molle per ogni soffione.

Nell'immagine 1 si evidenzia il primo movimento necessario:

caricare due molle vicine tra loro mettendole quasi in posizione verticale rispetto al soffione ed inserirle all'interno del foro precedentemente preparato. Rilasciare le stesse delicatamente.

For this spec shower-head with this specific mounting system, four springs are installed on each head.

In picture 1, you shall see the first needed movement to activate them:

Spring-load two springs next to each other placing them almost vertically and insert them in the hole in the ceiling; Release them gently;

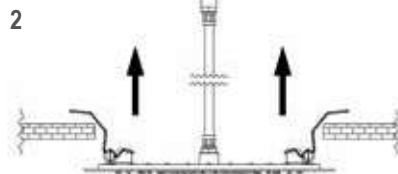

Mantenendo il soffione leggermente inclinato procedere caricando ed inserendo le rimanenti due molle come da immagine 2.

While keeping the shower head slightly inclined, proceed by spring-loading and inserting the two other springs as shown in picture 2.

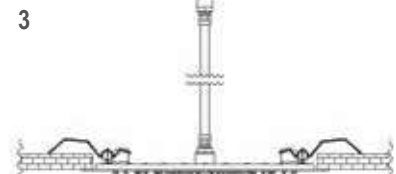

A questo punto rilasciare delicatamente le molle alla loro naturale tensione e, trattenendo esternamente il soffione, accompagnare lo stesso verso il totale appoggio al soffitto come da immagine 3.

Now release the springs back to their natural tension and, while holding the head from outside, guide it to its final position as shown in picture 3.

BODY JETS

**AUX34JETB**

Body jet da incasso quadrato 8x8 cm, in acciaio INOX lucidato a specchio per sistema doccia, anticalcare.

Built-in squared body jet 8x8 cm, in stainless steel mirror polished for shower systems, antilimestone.

**AUX34JETBN**

Body jet da incasso quadrato con getto nebulizzato, 8x8 cm, in acciaio INOX lucidato a specchio per sistema doccia, anticalcare.

Built-in squared nebulized body jet, 8x8 cm, in stainless steel mirror.

**BOCCE A CASCATA
WATERFALL SPOUTS**

**359XL**

Bocca a parete a L con getto a cascata, in acciaio INOX lucidato a specchio.

L-shaped wall-mounting spout with waterfall jet, mirror polished stainless steel.

itore di 1

**359XT**

Bocca rotonda a incasso con getto a cascata, in acciaio INOX lucidato a specchio.

Rounded built-in spout with waterfall jet, mirror polished stainless steel.

itore di 1

Disponibili da MAGGIO 2023 - Available from MAY 2023

SHUT-OFF



X65C25TW

Set per doccetta igienica shut-off comprensivo di miscelatore a incasso con leva minimale e presa acqua esterna, mensola portaoggetti integrata 100x210mm con supporto per doccetta, doccetta a pulsante in ottone, tubo flessibile 120cm.

Set for body cleaning including built-in mixer with minimal lever and external water connection, 100x210mm shelf with hand shower holder, brass hand shower with shut-off system, 120cm flexible hose.

nico



X65C25W

Set per doccetta igienica shut-off comprensivo di miscelatore a incasso con supporto doccia e presa acqua, doccetta in ottone con apertura a pulsante, tubo flessibile 120 cm. Cartuccia d.25.

Set for body cleaning including, built-in mixer with shower holder and water intake, cylindrical brass hand shower with shut-off system, 120 cm flexible hose. Cartridge d.25.

nico



X61PW

Set per doccetta igienica shut-off con cartuccia progressiva: apertura su acqua fredda e passaggio progressivo ad acqua calda tramite rotazione del supporto.

Il sistema di sicurezza integrato impedisce di aprire l'acqua quando la doccetta è inserita nel supporto e di riporre la doccetta prima di aver chiuso completamente la cartuccia. Set comprensivo di doccetta a pulsante in ottone e tubo flessibile cm 120. Cartuccia: d.25.

Set for body cleaning with progressive cartridge: opening on cold water and progressive transition to hot water by rotating the support. The integrated safety system prevents both turning on the water when the hand shower is placed in its holder and putting the hand shower back in the holder before having completely turned off the water. Set including brass shut-off hand shower and 120 cm flexible hose. Cartridge: d.25.

nico



X61W

Set per doccetta igienica shut-off. Il sistema di sicurezza integrato impedisce di aprire l'acqua quando la doccetta è inserita nel supporto e di riporre la doccetta prima di aver chiuso completamente la cartuccia. Set comprensivo di doccetta a pulsante in ottone e tubo flessibile cm 120. Cartuccia: d.25.

Set for body cleaning. The integrated safety system prevents both turning on the water when the hand shower is placed in its holder and putting the hand shower back in the holder before having completely turned off the water. Set including brass shut-off hand shower and 120 cm flexible hose. Cartridge: d.25.

nico

Disponibili da MAGGIO 2023 - Available from MAY 2023

OUTDOOR

**X63REWMVA**

Miscelatore incasso per shut-off su piastre separate, comprensivo di doccetta shut-off art. 332OW, supporto doccia-presa acqua con valvola di sicurezza e flessibile doccia cm 120.

NB: Le due parti a incasso sono indipendenti tra loro e permettono di posizionare i singoli elementi liberamente in base alle esigenze del progetto.

Built-in shower mixer set on double flange, including shut-off art. 332OW, shower holder water punch with safety valve and shower flexible cm 120.

NB: The two built-in parts are independent of each other and allow the individual elements to be positioned freely according to each project needs.



Colonna doccia da esterno in acciaio inox spazzolato, miscelatore monocomando a 2 vie con soffione tondo a pioggia anti-calcare e doccetta, acqua calda-fredda con attacco da pavimento.

Outdoor shower column in brushed stainless steel, 2-way single lever mixer with anti-limestone round rain shower head and hand shower, hot-cold water with floor connection.

SS331Q2L7MMUFM20

Con soffione doccia Ø20cm
With shower head Ø20cm

SS331Q2L7MMUFM25

Con soffione doccia Ø25cm
With shower head Ø25cm

SS331Q2L7MMUFM30

Con soffione doccia Ø30cm
With shower head Ø30cm

Disponibili da MAGGIO 2023 - Available from MAY 2023

2023

**NEWS CUCINA
KITCHEN NEWS**



**ACQUA DEPURATA
PURIFIED WATER**

PAG 60



ACQUA CORRENTE MISCELATA
MIXED RUNNING WATER



ACQUA DEPURATA
PURIFIED WATER

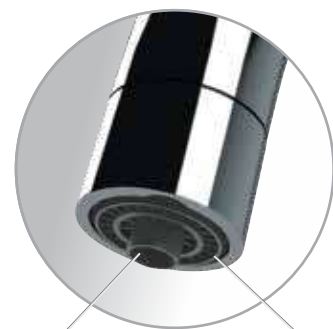

Acqua depurata
Purified water

Acqua corrente miscelata
Mixed running water

Due canali di erogazione
interni differenziati.
*Two separated internal
dispensing paths.*

Bocca girevole.
Swivel spout.

Leva di miscelazione per la
tradizionale gestione
dell'acqua corrente calda e
fredda.
*Mixing lever for the traditional
hot and cold running water
management.*

Selettore acqua potabile.
Ruotare di 90° in senso
orario per erogare l'acqua
depurata.
*Drinking water selector.
Turn 90° clockwise to
dispense the purified water.*



KIT ACQUA DEPURATA

Erogare l'acqua potabile filtrata direttamente dal rubinetto della cucina riduce drasticamente il consumo di bottiglie di plastica, i costi di trasporto e le conseguenti emissioni di Co2. Grazie alla collaborazione con BWT, nascono i KIT ACQUA DEPURATA: un'alternativa completa, sostenibile ed ecologica all'acqua in bottiglia.

Il miscelatore a 3 vie permette di accedere da un unico rubinetto sia all'acqua corrente che all'acqua depurata, mantenendo le due erogazioni separate per una totale sicurezza.

Il filtro BWT installato sotto il lavello rimuove dall'acqua corrente solidi e particelle sospese nonché odori e sapori indesiderati, per un'acqua buona, sana e a km zero.

I KIT ACQUA DEPURATA includono:

PURIFIED WATER KIT

Filtered drinking water directly from the kitchen tap drastically reduces the consumption of plastic bottles, transport costs and the resulting CO2 emissions. Thanks to the collaboration with BWT, the PURIFIED WATER KITS are available: a complete, sustainable and ecological alternative to bottled water.

The 3-way mixer allows access to both running water and purified water from a single tap, keeping the two outlets separated for total safety. The BWT filter installed under the sink removes solids and suspended particles from running water as well as unwanted smell and taste, for good, healthy and zero km water.

The PURIFIED WATER KITS include:



1

MISCELATORE A 3-VIE PER LAVELLO

Miscelatore a 3-vie per lavello con leva di miscelazione per acqua corrente calda/fredda e selettore laterale per acqua depurata. Percorsi di erogazione separati, aeratori separati. Bocca girevole. Raccordi di collegamento inclusi.

3-WAY MIXER FOR SINK

3-way sink mixer with mixing lever for hot / cold running water and side selector for purified water. Separate dispensing paths, separate aerators. Swivel mouth. Connection fittings included.

2

MONITOR

Il monitor viene installato sotto il lavello e permette di verificare in ogni momento lo stato del filtro. Consiste in un'unità di conteggio programmabile e collegata al filtro tramite un sensore di flusso per indicarne la capacità in tempo reale. Il monitor avvisa tramite un segnale acustico, quando il filtro è in esaurimento e quando è necessario sostituirlo.

MONITOR

The monitor is installed under the sink and allows you to check the status of the filter at any time. It consists of a programmable counting unit connected to the filter via a flow sensor to indicate filter capacity in real time. The monitor also alerts you with an audible signal when the filter is low and when it needs to be replaced.

3

FILTRO

Cartuccia filtrante BWT Bewapur HQ. Cartuccia a struttura composita in grado di trattenere impurità fino a 0,5 micron e rimuovere dall'acqua odori, sapori, colorazioni e corpi estranei non graditi. Il filtro viene installato direttamente sotto il lavello, collegato sia alla rete idrica che al miscelatore. Capacità del filtro a 12° dH 6000 l.

FILTER

BWT filter cartridge with BWT Bewapur HQ drink filter. Composite structure cartridge to retain impurities up to 0.5 microns and remove unwanted smells, flavours, colours and foreign bodies from the water. The filter is installed under the sink, connected to both the water supply outlet and the mixer. Filter capacity at 12 ° dH 6000 l.

4

TESTATA PORTA FILTRO

FILTER HOLDER

Caratteristiche tecniche:

Technical features:

Tipo di filtro - <i>Filter type</i>	Bewapur HQ S / Item code A890
Autonomia del filtro - <i>Filter life</i>	6000 litri - liter *
Finezza di filtrazione media - <i>Average filtration finenes</i>	0,5 micron
Portata nominale del filtro max. - <i>Max. nominal flow rate of the filter</i>	3,3 l/min
Dimensioni filtro + testata di connessione - <i>Filter size + connection head (H x D)</i>	270 x 100 mm

	FILTRI - FILTERS	RUBINETTO - TAP
Pressione di esercizio - <i>Operating pressure</i>	2 - 7 bar **	1 - 5 bar **
Temperatura consigliata ingresso acqua calda - <i>Recommended hot water inlet temperature</i>	-	60°C
Temperatura dell'acqua min. / max. - <i>Water temperature min. / max.</i>	4 - 30°C	4 - 80°C
Temperatura ambiente min. / max. - <i>Room temperature min. / max.</i>	4 - 40°C	4 - 40°C

* L'autonomia del filtro può variare in funzione della qualità dell'acqua di alimento. Sostituire il filtro al raggiungimento dell'autonomia o al massimo dopo un anno.
The autonomy of the filter may vary depending on the quality of incoming water. Replace the filter upon reaching autonomy or at the latest after one year.

** Per pressioni superiori prevedere l'utilizzo di un riduttore di pressione.
For higher pressures, use a pressure reducer.

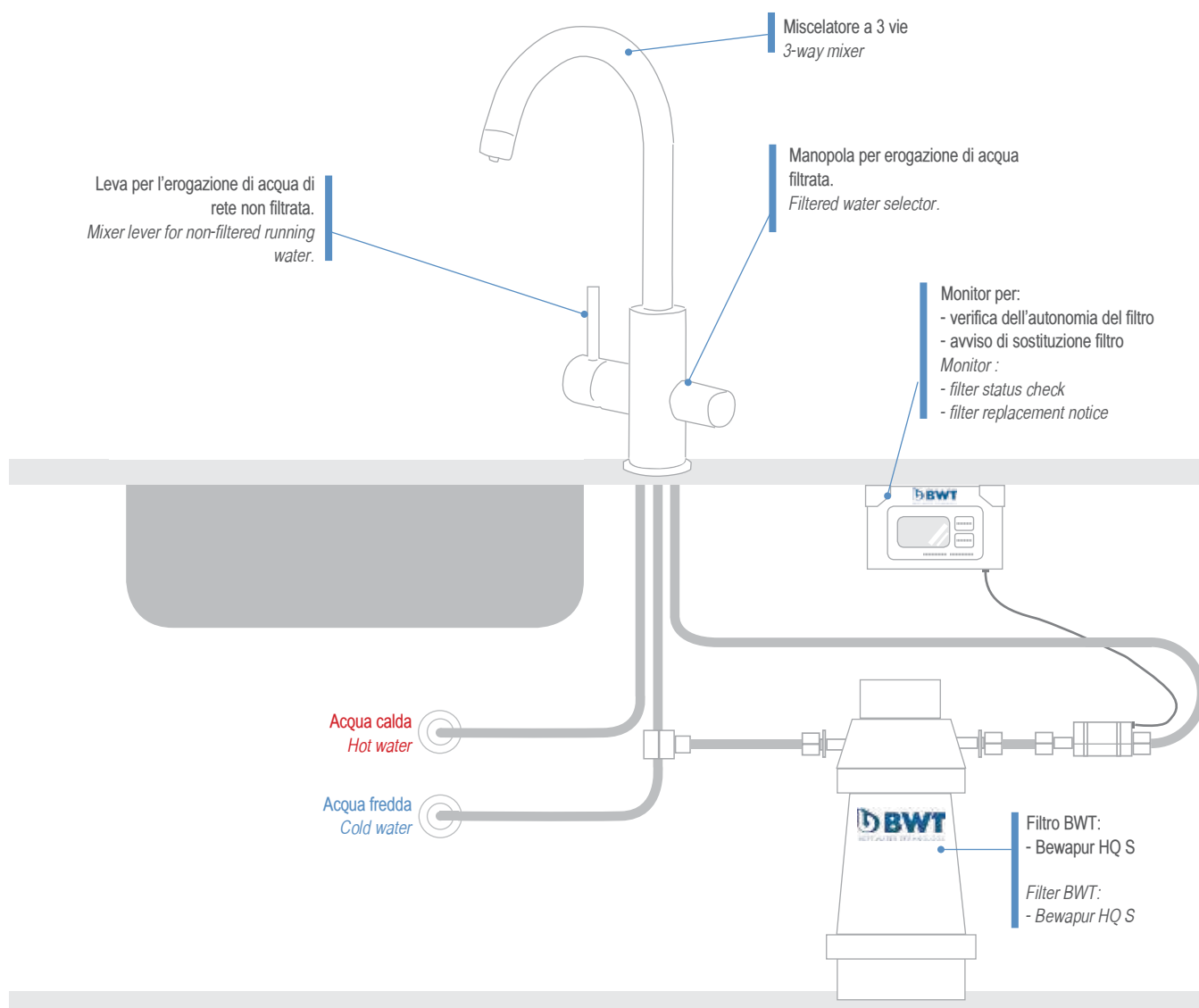



N792DW70J



Kit completo per acqua depurata, include: miscelatore a 3-vie con selezione acqua potabile tramite leva laterale, monitor, testata e cartuccia filtrante A890 (BWT Bewapur HQ S).

Complete kit for purified water, including: 3-way sink mixer with drinking water selection via side lever, monitor, head and A890 filter cartridge (BWT Bewapur HQ S).



EY79DW70J



Kit completo per acqua depurata, include: miscelatore a 3-vie con selezione acqua potabile tramite leva laterale, monitor, testata e cartuccia filtrante A890 (BWT Bewapur HQ S).

Complete kit for purified water, including: 3-way sink mixer with drinking water selection via side lever, monitor, head and A890 filter cartridge (BWT Bewapur HQ S).



L79DW70J



Kit completo per acqua depurata, include: miscelatore a 3-vie con selezione acqua potabile tramite leva laterale, monitor, testata e cartuccia filtrante A890 (BWT Bewapur HQ S).

Complete kit for purified water, including: 3-way sink mixer with drinking water selection via side lever, monitor, head and A890 filter cartridge (BWT Bewapur HQ S).

F70J

Cartuccia filtrante per ricambio BWT Bewapur HQ S, autonomia 6000 litri*.

BWT Bewapur HQ S replacement filter cartridge, autonomy 6000 liters.*



*L'autonomia del filtro può variare in funzione della qualità dell'acqua di alimento. Sostituire il filtro al raggiungimento dell'autonomia o al massimo dopo un anno.

The autonomy of the filter may vary depending on the quality of incoming water. Replace the filter upon reaching autonomy or at the latest after one year.



Disponibili da MAGGIO 2023 - Available from MAY 2023



LEGENDA ICONE - *ICONS LEGEND*

Prodotto Novità
New Product

Acciaio INOX
Stainless Steel

Disponibile in finitura
Finishings available

Click-Clack

Perfect Tune:
Prodotto disponibile
in più varianti.
Perfect Tune:
Product available
in different variants.

RUBINETTERIA - *FAUCETS*



Con scarico
With pop-up waste

1 plastic

Cartuccia Energy Saving
Energy Saving Cartridge



Con scarico in plastica
With plastic waste

1

Limitatore di Temperatura
Antiscalding

scarico pop-up 1

Con Click-Clack
With Click-Clak

Risparmio Idrico Dinamico
Water Saving Dynamic

waste

Con Click-Clack con Troppo Pieno
With Click-Clak with Overflow

Risparmio Idrico
Water Saving

Senza Scarico
Without Waste

Risparmio Energetico
Energy Saving

scarico i

Eco
Eco

Risparmio Idrico e Energetico
Water and Energy Saving

CUCINA - *KITCHEN*

Eco Eco

Bocca Girevole
Swivel Spout

1 Con

Bocca Abbattibile
Folding Spout



Corpo girevole
Swivel body

ck con 1

Doccetta a due funzioni
Two functions hand shower.

Doccetta Orientabile
Adjustable handshower

Acqua Frizzante
Sparkling Water

Doccetta Estraibile
Pull-Out Handshower

Acqua Potabile
Drinking Water

TECNOLOGIA - *TECHNOLOGY*

Touch-Me
Touch-Me



Azionamento a Sensore
Sensor Control

Tempor Touch
Tempor Touch



Con Temporizzazione per Lavatrice/Lavastoviglie
With Timing for washing/machine and Dish/Washer

Con Luce Led
Whit Led Light

Con filtro incluso
With filter included

mono Pi

Con Batterie Alcaline Incluse
With Alkaline Batteries included

100

Con Batterie al Litio Incluse
With Lithium Batteries included

Alimentazione Elettrica
Power Supply

19

Termostatico
Thermostatic

SOFFIONI - SHOWER HEADS

Getto effetto pioggia ad ampia copertura
Wide coverage rain effect

Getto effetto pioggia a risparmio idrico
Water-saving rain effect jet

 **Limit**
Con Multigetto
With Multi Jet

 **Statore di 1**
Con Getto a Cascata
With Waterfall Jet

 **ara**
Getto Nebulizzato
Nebulized Jet

 **OVERFLOW**
Cromoterapia
Colortherapy

 **ccia Ener**
Autopulente
Self-Cleaning

 **rgy Savi**
Con Getti Anticalcare
With Antilimestone Jets

KIT DOCCIA - SHOWER KIT

 **2 Vie**
2 Ways

 **3 Vie**
3 Ways

 **4 Vie**
4 Ways

 **5 Vie**
5 Ways

 **Flessibile Lungo 120 cm**
Flexible Length 120 cm

Flessibile Lungo 150 cm
Flexible Length 150 cm

Flessibile Lungo 200 cm
Flexible Length 200 cm

DOCCHETTE - HANDSHOWERS

Posizione d'interruzione getto
Stop flow position

Getto intenso esterno con getto effetto pioggia
interno
Intense external jet with internal rain effect jet

 **Con**
Getto intenso a risparmio idrico
Intense water-saving jet

 **Con**
Massaggio vigoroso ampia copertura effetto pioggia
Vigorous massage wide coverage rain jet

 **ck**
Getto vigoroso concentrato e getto esterno
Concentrated vigorous jet and external jet

Getto vigoroso concentrato
Vigorous concentrated jet

Getto Aerato Intenso
Intense Aerated Jet

Getto vigoroso effetto pioggia
Vigorous rain effect jet

Getto Vigoroso ed Ampio
Vigorous and Wide Jet

Getto spray ampia copertura e getto intenso esterno
a risparmio idrico
Wide coverage spray jet and intense water saving
external jet

 **570**
Getto soft aerato mischiato ad un getto vigoroso a
risparmio idrico
Soft aerated jet mixed with a vigorous water-saving
jet

 **emperat**
Pioggia soft a risparmio idrico
Soft rain water saving

Getto Esterno
External Jet

 **rgy Savi**
Con Getti Anticalcare
With Antilimestone Jets

COLONNE DOCCIA - SHOWER COLUMNS

 **570**
Colonna Doccia Girevole
Swivable shower column

 **Cartu**
Colonna Doccia Telescopica
Telescopic shower column

SLASH



DOT



REMER
RUBINETTERIE



ELEMENT



REMER
RUBINETTERIE



REMER RUBINETTERIE S.P.A.

Via Leonardo da Vinci, 83
20062 Cassano d'Adda (MI) Italy
Tel. +39 0363 364 211
info@remer.eu www.remer.eu